



**Signature Report**

**March 30, 2009**

**Motion 12950**

**Proposed No.** 2009-0154.1

**Sponsors** Constantine and Gossett

1                   A MOTION declaring an emergency and extending a  
2                   waiver from competitive bidding and solicitation  
3                   requirements for the King County Norm Maleng Regional  
4                   Justice Center hot water piping system replacement project.

5  
6                   WHEREAS, the hot water piping system in the King County Norm Maleng  
7                   Regional Justice Center ("MRJC") is a critical component of the heating and other  
8                   essential systems. When properly functioning, the system provides a safe and useable  
9                   environment to MRJC staff, inmates and the public. If the system does not function  
10                  properly, safety and use could be compromised, and

11                  WHEREAS, during routine maintenance and repairs to the piping system in  
12                  October 2008, King County maintenance workers noticed significant deterioration to the  
13                  condition of the pipes, and

14                  WHEREAS, the facilities management division has procured a consultant, Sazan  
15                  Group, Inc, ("MRJC consultants") who has central hot water piping system expertise, to  
16                  provide an assessment of the MRJC hot water piping system, and

17 WHEREAS, the MRJC consultants have concluded in a report dated January 13,  
18 2009, a copy of which is attached as Attachment B to this motion, that:

19 1. The existing hot water piping system has been found to be in a deteriorating  
20 condition and is at risk of imminent failure;

21 2. The cause of the problem is failing soldered joints on copper pipes;

22 3. A major break is likely and will cause a significant hazard releasing steam  
23 that will seriously harm any person nearby, and could potentially require evacuation of  
24 the facility; and

25 4. Replacement of the hot water piping system should proceed immediately, and

26 WHEREAS, the possibility of a failure in the MRJC hot water piping system  
27 constitutes an emergency that presents a real and immediate threat to the proper  
28 performance of an essential government facility, and will likely result in material loss or  
29 damage to property and injury to persons unless expeditious action is taken to mitigate  
30 the MRJC hot water piping condition, and

31 WHEREAS, the King County executive on February 4, 2009, issued a  
32 determination of emergency and waiver from competitive procurement and solicitation  
33 requirements for the MRJC hot water piping system project. A copy of the waiver is  
34 included in Attachment A to this motion, and

35 WHEREAS, an extension of the waiver from competitive bidding and solicitation  
36 requirements of state and county law is necessary to assure the timely procurement of  
37 design, construction and other required services, materials and equipment necessary to  
38 prevent delay in completing the MRJC hot water piping system project, and

39 WHEREAS, investigation of the extent of the piping system failure continues  
40 with potential that additional pipes may need replacement to avoid failure, and

41 WHEREAS, the cost for the project is currently estimated to be \$3,056,114 for  
42 replacement of the larger hot water pipes but may require revision based upon continuing  
43 investigation, and

44 WHEREAS, investigation continues as to the reasons for the pipe's deteriorating  
45 condition, and

46 WHEREAS, the prosecuting attorney's office has been asked to assist the  
47 facilities management division in an investigation as to who should be accountable for  
48 the pipe's deteriorating condition, and

49 WHEREAS, the King County executive has proposed an appropriation of  
50 \$3,056,114, to the major maintenance reserve fund to fund the MRJC hot water piping  
51 system replacement project as currently scoped, and

52 WHEREAS, extension of the waiver from competitive bidding and solicitation  
53 requirements of state and county law requires council approval by motion;

54 NOW, THEREFORE, BE IT MOVED by the Council of King County:

55 A. The waiver from competitive bidding and solicitation requirements of state  
56 and county law is extended until the project is completed to assure the timely  
57 procurement of design, construction and other required services, materials and equipment  
58 necessary to prevent delay in completing the MRJC hot water piping system project;

59 B. The King County council finds as a fact and declares that an emergency exists  
60

**Motion 12950**

---

61 and that this motion is necessary for the immediate preservation of public peace, health or  
62 safety or for the support of county government and its existing public institutions.

63

Motion 12950 was introduced on 3/2/2009 and passed by the Metropolitan King County Council on 3/30/2009, by the following vote:

Yes: 7 - Mr. Constantine, Ms. Lambert, Ms. Hague, Mr. von Reichbauer, Mr. Gossett, Ms. Patterson and Mr. Dunn

No: 0

Excused: 2 - Mr. Ferguson and Mr. Phillips

KING COUNTY COUNCIL  
KING COUNTY, WASHINGTON

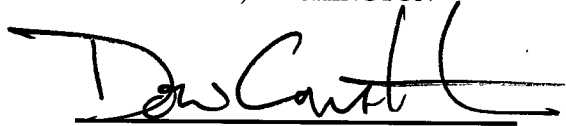

Dow Constantine, Chair

ATTEST:

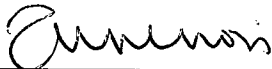

Anne Noris, Clerk of the Council

**Attachments**

A. Executive Determination of Emergency and Waiver from Competitive Procurement and Solicitation Requirements for the Maleng Regional Justice Center (MRJC) Central Hot Water Heating System, B. King County Norm Maleng Regional Justice Center - Kent Heating Piping Assessment Final Report by Sazan Group, Inc., Dated January 13, 2009



## King County

EXECUTIVE DETERMINATION OF EMERGENCY AND WAIVER FROM  
COMPETITIVE PROCUREMENT AND SOLICITATION REQUIREMENTS FOR THE  
MALENG REGIONAL JUSTICE CENTER (MRJC) CENTRAL HOT WATER HEATING  
SYSTEM

WHEREAS, the central hot water piping system in the King County Norm Maleng Regional Justice Center (MRJC) provides the heat source for the facility; and,

WHEREAS, the hot water piping system is a critical component of the detention and superior court system. When properly functioning, the hot water piping system provides a safe and useable environment to MRJC and court staff, inmates, and the public. If the system does not function properly, that safety and use could be compromised; and,

WHEREAS, the present piping in most cases dates from the original construction of the MRJC eleven years ago; and

WHEREAS, during routine maintenance and repairs to the piping system in October 2008 King County maintenance workers noticed significant deterioration to the condition of the pipes; and,

WHEREAS, the Facilities Management Division has procured a mechanical engineering consultant, Sazan Group, with central hot water heating system expertise, to provide an assessment of the MRJC hot water piping system; and,

WHEREAS, the Sazan Group has concluded in a report dated January 13, 2009, that (a) the existing hot water piping system has been found to be in a deteriorating condition and is at risk of imminent failure; (b) the most critical components are the copper piping of the central hot water heating system to the water heaters (heat exchangers) and to the rooftop air conditioning units; (c) a major pipe break is likely and would be a serious hazard; (d) if a break occurs without a change in operating temperatures, water will flash to steam and raise the temperature in the vicinity to 212 degrees Fahrenheit and scald any person nearby; and (e) replacement of the system should proceed immediately; and,

WHEREAS, the possibility of a failure in the MRJC hot water piping system constitutes an emergency that presents a real and immediate threat to the proper performance of an essential government facility, and will likely result in material loss or damage to property and injury to persons unless expeditious action is taken on the MRJC hot water piping; and

WHEREAS, an emergency waiver of competitive bidding and formal solicitation requirements of state and county law is necessary to assure the timely procurement of design, construction and other required services, materials and equipment necessary to prevent delay in completing the replacement of the hot water piping system project.

WHEREAS, Sazan Group, Inc., the consultant, is proposed to be selected for this project to perform because of their central hot water piping system expertise, their familiarity with the MRJC and their unique understanding with this problem gained during the preparation of January 13, 2009 MRJC Heating Piping Assessment Report.

WHEREAS, the contractor, Auburn Mechanical, is recommended by the consultant based on their knowledge of the contractor's past performance on projects with similar scope, scale and complexity, including within correctional facilities. Facilities Management Division staff has reviewed their qualifications and are confident that they are well qualified for the work and will provide necessary bonding and insurance.

WHEREAS, the full costs of the MRJC Central Hot Water Piping System Project is estimated to be \$3,056,114 to cover all costs and expenses associated with design, construction and project management for completion of the project.

NOW THEREFORE THE KING COUNTY EXECUTIVE, RONALD SIMS, HEREBY DETERMINES AND DECLARES AS FOLLOWS:

#### SECTION 1

In accordance with RCW 39.04.280 and KCC 4.16.050 there is an emergency due to the imminent danger of the MRJC hot water piping system failing, and as a result, immediate steps must be taken to preserve the health, safety and welfare of the public, King County employees, MRJC inmates and the MRJC facility.

SECTION 2

The requirements for competitive bidding and formal solicitation of design, construction and other required services, materials and equipment under Chapter 36.32 RCW, Chapter 39.80 RCW, and K.C.C. chapters 4.04, 4.16, 4.18, 12.16 and 12.18., and all applicable King County Executive policies and procedures are hereby waived with reference to any such contracts relating to the replacement of the hot water piping system as described in the Sazan Report. This waiver shall continue in full force and effect until all necessary contracts are executed, or until terminated by subsequent order of the King County Executive, action by the Metropolitan King County Council by ordinance, or as otherwise may be required by law.

DATED this 4 day of February, 2009

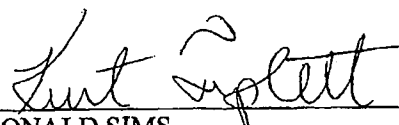
  
for RONALD SIMS,  
King County Executive  
State of Washington

Sazan  
Group  
Inc.

# **KING COUNTY**

## **Norm Maleng Regional Justice Center - Kent**

### **Heating Piping Assessment Final Report**

Report Date:

November 20, 2008  
Revised January 13, 2009

Delivered To:

King County Facilities Management Division  
KC Administration Building  
500 Fourth Avenue  
Seattle, WA 98104

Prepared By:

**Sazan Group, Inc.**

720 Olive Way

Suite 1525

Seattle, WA 98101

Tel (206) 267-1700

Fax (206) 267-1701



**Table of Contents**

	<u>Page</u>
❖ Acknowledgements	i
❖ Executive Summary	1
❖ Existing Conditions	
– Facility Description	4
– Central Heating Water System	6
– Site Observations	11
❖ Recommendations	15
❖ Cost Estimate Summary	18
❖ Appendix 1 – Cost Estimates	20
❖ Appendix 2 – Drawings	26
❖ Appendix 3 – Photographs	30
❖ Appendix 4 – Testing Lab Results	38



## Acknowledgements

This report was developed under the direction of Mike Lozano, Capital Project Manager, Capital Planning and Development, Facilities Management Division, Department of Executive Services, King County.

The Sazan Group team included the following testing agencies:

- ❖ NVL Labs, Nick Ly
- ❖ MDE, Inc., Keith Cline, PE

We would like to thank members of the King County Facilities Management Division for their assistance and input to this report:

- ❖ Mike Lozano
- ❖ Art Green
- ❖ Jim Burt
- ❖ Greg Kuhn

Our field testing and investigation was supported and enhanced by the following King County employees, and we want to thank them for their cooperation and help:

- ❖ Jim Nitz, King County Maintenance Shop, Maintenance Supervisor
- ❖ David Morse, King County RJC Plumbing Shop, Maintenance Supervisor
- ❖ Don Jones, King County RJC Facilities Shop, Maintenance Supervisor, Central Plant
- ❖ Bob Hill and Bowhan Basisty, King County RJC Facilities Shop, Central Plant

Sazan Group technical team included the following individuals:

- ❖ Richard M. Ward, PE
- ❖ Nader Dabestani, PE
- ❖ Julian Miskimen

Sazan  
Group  
Inc.



**Executive Summary**

The facility in this study is the Norm Maleng Regional Justice Center located in Kent, Washington. The facility has approximately 770,000 square feet of floor area and has 800 detention cells and 23 courtrooms.

Heating water piping within the eleven-year-old facility has been found to be in poor condition and at risk of imminent failure. The heating water system is the primary means of heating the facility and conveys the heat from the boilers in the Central Plant Building to the entire facility to heat domestic water and the occupied living areas. A major pipe break is likely within the next six months and would be a serious hazard and would scald anyone—staff or detainee—in the vicinity. A major break could endanger the operations of the facility for an extended period as repairs were made. That risk must be mitigated.

Furthermore, this situation constitutes an “emergency” as defined in the King County Code (KCC). As stated in paragraph 4.16.050 of KCC, this work is necessary “for the immediate preservation of order” and the “restoration of a condition of usefulness of any public property”. We concluded that the following conditions meet those criteria:

1. A major pipe break is likely.
2. A break could endanger staff and/or detainees.
3. Without heat in the winter the facility would be required to be evacuated.
4. King County has substantial liability injuries from a pipe break.

The weak pipes should be replaced as expeditiously as possible. The County should enter into an expeditious contract with Auburn Mechanical Contractors as the most available, qualified contractor to perform this work.

The piping at risk is the smaller copper piping of the Central Hot Water Heating System (CHWS and CHWR piping on the drawings) to the water heaters (heat exchangers) in the housing units and to the piping to the rooftop air conditioning units. The three-inch and smaller piping should be replaced with black steel piping where it is subject to high boiler water temperatures. The larger steel piping (four-inch and larger) immediately off the boilers appears to be satisfactory. The piping at risk is located throughout the facility and should be replaced.

This situation was discovered October 23, 2008 by facility maintenance staff as they tried to repair leaks. It may have been a chronic source of leaks for an extended period. Sazan Group was called to the site on October 29 to review the situation and to inspect several pipe samples. Some of the pipe fittings had been removed from one of the water heaters. The piping was cut into pieces and the fittings were cut longitudinally. The fittings came apart with a tap on the work bench.

The water system was estimated to have a serious scalding potential, so Richard Ward, PE, of Sazan Group directed the boiler temperature to be lowered from 260 degrees F to 200 F. The system has been operating at 200 F since October 29, 2008.

Sazan  
Group  
Inc.

From an operational view, we can expect that with the lower water temperature, the indoor space temperatures will be harder to maintain. So far this year with mild outdoor temperatures, full capacity of the heating system has not been necessary. There have been few complaints about the space temperature, but the outdoor temperature has been comparatively mild. When the outside temperature drops to near the design temperature of 17 degrees F, we would expect the indoor temperature to be uncomfortably cool, perhaps below 60 degrees.

The cause of the problem is soldered joints on the copper pipe. Soldered joints are rated for 250 degrees F and not for 270 degrees F. The boilers are listed for 270 degrees F although they have been operated at 260 degrees F. The pipe should have been welded steel where it was subject to 250 degrees F or hotter.

If a major pipe break were to occur on the 260 degree F line, the water would flow out of the pipe and would immediately flash to steam. The resulting cloud of steam would raise the temperature in the vicinity to 212 degrees and scald any person close by. People will suffer second or third degree burns and may die. The loss to the County will be for the emergency for the staff and inmates involved, financial loss for those individuals, and the potential closure of the facility for the 800 inmates.

The situation has been improved with the lower water temperature, but the following issues remain:

1. The building has operated with the 200 degree F water since October 29, 2008 with only minor complaints.
2. Unfortunately, the damage to the pipe has been done; pipes will be weak until replaced. If they break, severe damage could result and liability remains.
3. The outdoor temperatures have been comparatively mild since the problem was encountered. There have been few hours below 30 degrees F outside temperature, but many hours in the teens and twenties can be expected in the next several months. The design temperature for the building is 17 degrees F and the recorded low temperature is below zero degrees F.
4. The 200 degree F water is unlikely to be sufficient to heat the building in extreme cold weather since all of the heat exchangers were sized based on the 260 degree F water. A higher water temperature than 200 F may be required to heat the building.

The weak pipes should be replaced as expeditiously as possible. The estimated Maximum Allowable Construction Cost (MACC) for pipe replacement is \$2,038,000 (see attached). The expedited contract will allow work to start sooner and give the County more flexibility in scheduling and thereby reduce risk of life hazard and financial loss.

Repair is not advisable, as it would be much more labor intensive to clean and replace each joint in-place with brazed joints than to replace with new steel pipe (see Appendix 1 - Cost Estimates).

Sazan  
Group  
Inc.





**Facility Description**

The facility in this study is the Norm Maleng Regional Justice Center located in Kent Washington (south King County). The facility houses approximately 900 people, consisting of detainees and staff, and is operated 24 hours per day, seven days a week. The King County Courts for South King County operates during daytime hours.

To understand the interrelationship of the heating system to the rest of the facility, it is necessary to have a basic knowledge of the overall facility.

The basic facility is composed of three distinct buildings—the courts, the detention area, and the central heating and cooling plant. See Appendix 2 – Drawings.

- A. The Courts Building: The building is five stories with 23 courtrooms, jury rooms, judges' chambers, administrative space, and holding cells on the Ground Floor and First through Fourth Floors with a penthouse. The dome on top of the Rotunda is a landmark feature in Kent.
- B. The Detention Building: The building is a two story building divided into 16 semi-autonomous units each with 64 detention cells and a day room and exercise yard with a combined total of approximately 800 detention cells for detainees prisoners (approximate because an approximate count of existing drawings was made). The building also includes parking areas for approximately 380 vehicles, facilities support areas including shops, a kitchen and cafeteria, and a loading dock. The floors are Ground Floor and First Floor with penthouse equipment, mainly air handlers.
- C. The Central Heating and Cooling Plant: This building includes the major utility support equipment including:
  - 1. Heating Equipment – Boilers (Hot water for building heating and steam for the Kitchen), pumps, and accessories.
  - 2. Cooling Equipment – Chillers, pumps, cooling towers, and accessories
  - 3. Electrical generators and switchgear.
- D. An area summary includes:
  - 1. Courts.....230,000 SF
  - 2. Detention .....507,000 SF
  - 3. Central Plant ..... 7,800 SF
  - 4. Total area .....744,800 SF

Sazan  
Group  
Inc.

**Facility Description  
continued**

- E. Building Plans: The 150 building mechanical plans are organized with four digits as follows:
1. 80 Series: Legend notes and equipment schedules
  2. 81 Series: Not used
  3. 82 series: Plumbing and Piping Plans
    - a. 82.0X series: Courts Building
    - b. 82.1X series: Detention Building Area 1 (Detention Building is divided into 6 areas). Within Area 1, there are Detention Units D and E and Unit B which includes intake, transfer, release, and administration.
    - c. 82.2X series: Detention Building Area 2 includes Detention Units F, G, and H and parking.
    - d. 82.3X series: Detention Building Area 3 includes Detention Units J and K, and parking.
    - e. 82.4X series: Detention Building Area 4 includes Detention Units L and M and the clinic.
    - f. 82.5X series: Detention Building Area 5 includes Detention Units N and P and the kitchen.
    - g. 82.6X series: Detention Building Area 6 includes Detention Units Q, R, and S and the facility shops.
    - h. 82.7X series: These drawings show the north-south utility chase between Areas 1, 2, and 3 to the east and Areas 4, 5, and 6 to the west.
  4. 83 Series: HVAC. The general organization within Areas 0 through 6 are repeated.
  5. 84 Series: Fire Protection
  6. 85 Series: Enlarged Plumbing and HVAC Piping
  7. 86 Series: Detention Units Plumbing Sections
  8. 87 Series: Detention Units HVAC Sections

## Central Heating Water System

### Overview

The Central Heating Water System (CHWS) for the Regional Justice Center (RJC) is a high-temperature heating water system, which is somewhat unusual. It is used as an alternative to a steam distribution system to minimize the historic issues with a steam system. As described elsewhere in this report, there are other issues to address. The CHWS water was designed to be heated to 270 degrees (212 degrees F is the boiling temperature of water at atmospheric pressure) although it has been operated at 260 degrees F.

The water is heated in large scotch-marine fire-tube boilers in the Central Plant Building. The water is heated to 260 degrees F and pumped to the various areas of the detention and courts buildings. The CHWS water is used to heat the following types of equipment, these are all the heat exchangers in the facility:

- A. Domestic water in water heaters (WHs) in each detention unit.
- B. Space heat via heat recovery air handlers (HRUs) in the detention units.
- C. Space heat via built-up air handlers (AHUs) in the Courts and Central Plant Buildings.
- D. Space heat in VAV boxes (FBCO = Fan box constant output) and fan coil units (FCUs) in the Courts Building and Detention Building.

The water pipe leaving the building is an 8-inch to the main building. The water piping returns (CHWR) to the Central Plant and is heated again and the cycle is repeated. The CHWR generally runs parallel to the CHWS throughout the building.

### Central Equipment

The central equipment includes the following:

- A. Boilers: There are two boilers B8-1 and B8-2 each rated for 600 boiler horsepower, 1340 GPM with 240 degree F entering water and 260 degrees F leaving water with either gas or oil as the fuel source and rated at 82 to 88% efficiency. Each boiler produces approximately 20,000 MBH (thousands of Btu/hr). The boilers are rated at 270 degrees F and have been operated at 260 degrees F as a selection of the plant engineers.
- B. Pumps:
  1. Two primary pumps, P8-9 and P8-10, circulate the CHWS water at the boilers to assure circulation at the boiler. Each pump is rated for 1340 GPM and 42 feet of head, and 20 motor horsepower.

**Central Heating Water System  
continued**

2. Two secondary pumps, P8-11 and P8-12, distribute the CHWS water to the building. Each pump is rated for 1267 GPM and 90 feet of head, and 40 horsepower and have been modified since the original construction to include variable frequency drives (VFDs).
- C. Accessories include:
1. Each boiler has separate make-up water connections.
  2. Each boiler has its own air separator.
  3. Each boiler pump has its own suction diffuser.
  4. There are two combined expansion tanks for the loop.
- D. An adjacent steam boiler rated at 250 boiler horsepower produces 90 psig steam, but it does not connect to the CHWS system. It serves the food service and the laundry.

**CHWS Distribution**

The distribution of the CHWS system serves the following types of equipment. Each has different requirements associated with the fluid temperatures involved (data listed below is compiled from the original contract drawings).

- A. Domestic water in water heaters (WHs) each detention units:
1. The water heaters generate hot water primarily for the detainee's showers.
  2. The heaters are shell-and-tube heat exchangers
  3. The flows are scheduled as follows (typical of 15 heaters):
    - a. Hot side: 38 GPM to and from the heat exchanger of CHWS at 270 degrees F inlet, 205 degrees F outlet.
    - b. Cold side: 34 GPM of domestic water to and from the heat exchanger from 50 degrees F to 120 degrees F.
    - c. Heat flow of 1,180 MBH in each heater or 18,880 MBH in 16 water heaters (or approx 90 % of one boiler). The usage of the facility varies as the schedule in the dormitory blocks, but generally during prescribed times of the day. We would not expect all heaters to peak at the same time so there would be a peak utilization of some reduced amount (or diversity).

- B. Space heat via heat recovery air handlers (HRUs) in the detention units.
1. These units provide warm air to heat the detention areas, one per housing unit.
  2. The CHWS system provides heat to keep the facility warm. The CHWS is a secondary source of heat after the heat recovery internal to the unit has worked.
  3. The flows are scheduled as follows (typical of 15 HRUs):
    - a. Air flow: 17,000 CFM of outside air (supply air).
    - b. Heat recovery is selected at 78% efficiency so outside air is warmed from 24 degrees F to 57 degrees F. (From discussion with operating engineers these heat recovery devices are performing well.)
    - c. 22 GPM of CHWS from 190 degrees F to 170 degrees F using mixed water from CHWS main (7 GPM) at 270 degrees F. The 270 degree water from the boiler is mixed at the HRU to enter the HRU at a lower temperature than the CHWS, in this case 190 degrees F.
    - d. Heat flow is 746 MBH at each coil or 12,682 MBH in 17 HRUs (or approximately 63% of either boiler. We would expect all heaters to peak at near the same time as they all operate with the primary variable being outside air temperature which is the same for each.
- C. Space heat via built-up air handlers (AHUs) in the Courts and Central Plant Buildings and other locations:
1. These units provide warm air to warm up the Courts and Central Plant Buildings in the mornings and to offset cold outside air on the coldest days.
  2. Each AHU has a pump associated with it.
  3. Some of the AHUs have return air and some do not.
  4. The flows vary between 16 different coils with a total of approximately 400 GPM at 180 to 230 degrees F.
  5. Total heat flow is approximately 4,000 MBH at peak.
- D. Space heat in VAV boxes and fan coil units (FCUs) in the RJC Buildings.
1. These units temper the air in the individual thermostatic zone as in the Courts Building.

2. There are approximately 160 of these coil connections with one to nine GPM rated for 180 degrees F with leaving of 165 F.
3. There is a peak heat flow of approx 2,000 MBH.

#### **Advantages of CHWS System**

Heating systems like those of the Norm Maleng Regional Justice Center are often referred to as high temperature water systems (HTW) (although some people refer to these as medium temperature water systems, reserving the name HTW for systems above 350 degrees F). The advantages of these systems as compared to steam distribution systems include:

- A. The system is closed circuit and less prone to corrosion.
- B. The system can slope up or down without the slugging of steam condensate or condensate traps and pumps.
- C. The high heat content of water acts with a thermal storage affect which improves control stability.

#### **Lower Temperature Operations**

The operating temperature is set by the usage of the various heat exchangers. Each heat exchanger has a hot side and a cool side. In each of the types of heat exchangers above, the hot side is the CHWS system. In each case there is substantial differential between the hot side and the cool side even when the water temperature is lowered:

Example 1: Domestic Hot Water: The CHWS is 260 degrees F and the leaving domestic water temperature is 120 degrees F or a differential of 140 degrees. By lowering the CHWS temperature to 200 degrees F there is still 80 degrees of differential.

Example 2: HRUs, Heat Recovery Air Handler Units: The CHWS is 260 degrees F and the water is mixed with the return water to provide 190 degrees F to the heating coil in the HRU. At design, 7 GPM of 260 degree water mixes with 28 GPM of 170 degree water to produce 190 degree water. At 200 degrees F of CHWS water, it will require 23 GPM of 200 degree water to mix with 12 GPM of 170 degree water to provide the same conditions. The effectiveness of the heat exchanger is determined by the demand, heat exchange surfaces, and fluid flows.

After the repairs are in place the functionality will be improved. It is quite possible the HRUs will work fine with lower entering water temperature from CHWS, but as stated above that depends on the demand for heat, heat exchange surfaces, and fluid flows.

The real proof is the actual functional tests at design conditions. Unfortunately, at design conditions it may be too late to make modifications and the facility will go out of control and be too cold. That can be predicted and the water temperature can be allowed to rise when outside temperature goes down.

After the repairs are in place, we would recommend a linear variation of boiler circulating temperature with outside air temperature. For instance the boiler temperature can be reset to 210 degrees if outside temperature drops below 45 degrees F, and to 220 degrees F if outside temperature drops below 30 degrees F and to 230 degrees if outside temperature drops below 15 degrees F.

Final set-points for these conditions will require some further analysis and adjustment during operations.

It may be possible that the boilers will need to return to maximum temperature. That can not be determined until the revised facility has been occupied through a winter. The projection is for 230 degrees F as a maximum temperature, but the facility will be the determining factor. As a precaution the piping needs to be suitable for the 260 degrees F.

**Site Observations**

A. Background:

1. On October 23, 2008, the RJC plumbers found a disturbing segment of 1-1/2-inch pipe near a water heater in housing unit G. They were drawn to the location to fix some chronic water leaks from that particular segment of pipe. Other pipe over the years has been similarly repaired.
2. On this particular day they were concerned for the overall integrity of the system and called in the downtown FMD (Facilities Maintenance Department) to contact a consultant to review the situation.
3. On October 29, 2008, a request was made for Sazan Group to review the situation and on that day Richard Ward went to the site. Observations are as follows:

B. Pipe Samples

1. A segment of pipe approximately 4 feet long was examined. The pipe was copper and the joints appeared to be soldered with poorly made joints as evidenced by irregular darkened streaks at the joints. See Appendix 3 - Photographs.
2. Several of the joints had white granular puffy projections from the joint.
3. Several joints were cut from the larger segment of pipe. Those pieces were cut longitudinally. When those pieces were tapped on the workbench, they fell apart. Several pieces like that were examined and each fell apart. The inside surface of the joints were blackened, unevenly.
4. The joints were not brazed. Brazed joints are raised in temperature enough to blacken the outside of the joints and the joints were comparatively clean.
5. By comparison a newly soldered joint was made and examined. That joint was also sawed apart longitudinally. That joint had to be forced apart and when we did that, the joint surfaces were shiny and silver colored.

C. Initial Questions

1. We wanted to make sure that the pipe sample was not an isolated section of pipe. David Morse of the Plumbing Shop was directed to take three additional samples at other heat exchangers in other areas of the facility.



2. We wanted to know what could cause this situation. Sazan had tabular data showing that copper pipe could be joined by soldering or brazing. Soldering is rated for different pipe sizes and methods. The most applicable data are as follows:
  - a. 1-1/2-inch pipe with 50-50 lead solder is rated for 75 psig pressure at 250 degrees F (it is not rated at 260 or 270 degrees F).
  - b. 1-1/2-inch pipe with 95-5 tin antimony solder is rated at 175 psig pressure at 250 degrees F (it is not rated at 260 degrees F).
  - c. 1-1/2-inch pipe brazed joints are rated at 190 psig pressure at 350 degrees F.
  - d. Clearly the only method at 260 degrees F would have been brazing but the installed joints are not rated for that temperature.
3. We wanted to know what the pipe joints were made of. Sazan was directed to have the pipe tested by a materials laboratory. For results, see Appendix 4.

D. Initial Findings – October 29

1. The imminent pipe failure was cause for grave concern. The pipe appeared to be on the verge of immediate collapse or rupture. A cataclysmic failure would spill a large volume of 260 degree F water under pressure. That water would immediately turn to steam and saturate the room in which the spill took place and scald anybody in the area. As the pipes pass through confined areas where service personnel and inmates could be, there was real possibility of serious injury or loss of life.
2. As a precaution the facilities staff was directed to lower the boiler water temperature to 200 degrees F. The set-point temperature had already been lowered by staff to 235 degrees F and they were preparing to lower it 10 degrees per day. Sazan directed the temperature to be lowered to 200 degrees that day. The temperature was observed to drop approximately 10 degrees per hour. At the lower temperature, less heat can be conveyed in the existing heat exchangers. The result may be less domestic hot water for showers and less heat for indoor space environments.

E. Second Day of Observations – October 30

On October 30 another set of observations was made to validate the previous findings. The following was found:

**Site Observations  
continued**

1. Three additional samples were observed with the same results as the previous day.
2. We discussed chemical treatment with Bob Hill of the RJC staff. Bob described a pattern of adding chemicals periodically, approximately every two weeks. He adds a combination of sodium nitrate, sodium polytriazole, and sodium hydroxide to maintain 900 PPM. The white granular puffy projections are consistent with those chemicals. The internal water seeps out and the water evaporates, leaving granular chemicals.
3. We took additional photographs; see Appendix 3.
4. Since the previous day, the boiler temperature had been consistently 205 to 210 degrees F and it was lowered to 200 degrees F.
5. Lowering the water temperature had not caused complaints. Outdoor temperature had been approximately 50 degrees F at night.

**F. Testing Labs**

Pipe samples were tested at two laboratories with the following results – See Appendix 4:

1. NVL: Samples were tested on October 31, 2008 and found to be:
  - a. Old sample: 0.017 % Lead
  - b. New pipe: Less than 1.0 PPM Antimony and 2.8 PPM Lead.
2. MDE Inc: Samples were tested in November 2008 and found to be:
  - a. Tin-antimony solder.
  - b. Joints were poorly made as the solder was uneven in the joints.

**G. Solder vs. Brazing vs. Welding – Definitions**

Copper pipe is most commonly joined by soldering or brazing:

1. Soldering is a process in which a joint is made between two pieces of copper with an intermediate metal between the two pieces of copper. The copper joint is heated with flux and then the intermediate metal is melted between the copper and flows to “wet” the entire surface. The bond it makes as the copper bonds to the melted intermediate metal and the other surface is also bound to the intermediate metal.

In this case the intermediate metal is a tin-antimony solder (in 95-5% combination). The joint is heated to approximately 450 degrees F and the joint is formed (copper melts at 726 degrees F). Solder of 95-5 is commonly used in joining copper pipes, and it is the most common solder for domestic water pipe. Another alternative solder is tin-lead in 50-50 combination. That combination has been largely banned as the lead is potentially harmful. The relative strengths of the two solders are mentioned above.

2. Brazing by comparison is a much hotter process. The filler metal has a lower melting point than copper. The joint is made by heating the metals to over 700 degrees F and the filler metal melts and adheres to the copper and the joint is made. The brazed joint is much stronger (see data above).
3. Welding, by comparison, is a method in which the two surfaces of the pipe (usually steel pipe) being joined are both melted and the bond is made. In most applications an alloy of steel is melted between the two ends of the pipe and flows into the melted end surface of the two pipe ends.



## Recommendations

Based on our assessment of the site circumstances and operational procedures, we recommend the following:

- A. Replace the at-risk copper pipe with welded black steel pipe. These pipes are in the following areas:
1. The pipes from the mains to the domestic water heaters are located in the housing units. These are typically 1-1/2-inch in size.
  2. The pipes from the mains to the heat recovery air handling units are located in the housing units. These are typically 1-inch in size. The replacement should be with de-coupled secondary piping with new pumps.
  3. The pipes from the mains to the rooftop air handling units in the Courts Building are located on the roof. These are typically 1-inch in size. The replacement should also be with de-coupled piping and pumps. There are also 1-1/2" pipes to three air handling units in the Central Plant Building which should be replaced.
  4. The pipes from the mains to the pumps serving the zones of the VAV boxes located in the D and E housing units and in the Courts Building. These are typically 3-inch in size. The 3-inch main from the housing units to the Courts Building should also be replaced.

The larger pipes in the building—the four-, six-, and eight-inch pipes—are presently welded steel and are not considered at-risk; no repair is recommended.

- B. The pipes should be replaced as soon as feasible. The pipes observed on site are weak and at risk of imminent failure. In the weakened condition any of several normal events could cause failure, for instance:
1. Improper handling by staff or inmates.
  2. Water hammer due to cycling of valves.
  3. Thermal expansion and contraction.
  4. Earthquakes that cause shaking of the pipes.
  5. General fatigue.
- C. We have discussed the replacement with copper pipes with brazed joints but the copper is part of the problem and brazing joints are more difficult to control for the work in the housing units. Welded steel pipe is more easily controlled.

**Recommendations  
Continued**

- D. We have discussed adding valves between the mains and the heat exchangers. In general these are in place. We have not found an exception as yet. If they are found to be missing, valves will be added where found to be missing. If the valves are found to be of the wrong type (the operating engineers referenced some butterfly valves which are the wrong type valves at these temperatures), the valves will be replaced with gate valves. This will allow independent shut-down of a branch to expedite the changing of the branch piping either as a matter of the overall work recommended above or to facilitate on-going shut-downs in case of major leakage in the future.
- E. Existing welded black steel pipe in larger sizes on the main distribution pipes may remain – sizes 8-inch, 6-inch, and 4-inch. These pipes are located above the ceiling along grid 40 for a distance of approximately 700 feet from the boiler room.
- F. Existing copper pipe downstream of the mixing valves and pumps on the distribution zones are subjected to temperatures only up to 190 degrees F so they may remain. There is approximately 12,000 lineal feet of this type pipe and includes connections to 160 VAV boxes and fan coil units.
- G. The boiler temperature should be maintained in a range of temperatures from 190 to 200 degrees F as much of the year as possible. Allow for an automatic reset of this temperature based on outside air temperature. This temperature should be reset initially to a maximum of 200 degrees F if the outside temperature is below 20 degrees F and to 190 degrees if the outside temperature is above 60 degrees F and the temperature should vary linearly in between. As a contingency, it may be found that during very cold weather the boiler temperature is not hot enough. In that case, the temperature should be reset higher up to a maximum of 230 degrees F. This feature has the following advantages:
1. The scalding potential of a pipe break is significantly reduced.
  2. The energy to heat the facility will be reduced due to lower water temperature. Savings will occur because there is less heat loss from the lower temperature water pipe and boilers are more efficient at lower temperature.
  3. The comfort conditions of the staff and detainees will be maintained.
  4. The risk of carry-over of the high temperature water into areas of piping that may be vulnerable to damage is reduced.

Although not anticipated, the boiler water temperature can be reset higher than the values listed above if operational temperature does not prove satisfactory. This will be verified during the commissioning process.

**Recommendations  
Continued**

- H. Revise the piping serving the HRUs serving the kitchen to facilitate the higher heat output necessary to allow the boiler temperature to remain lower.
- I. When the piping is replaced, the new pipe will be insulated as called for in current standards.
- J. Install controls to monitor pressure in the CHWS and CHWR lines in the vicinity of the boiler and to trip a planned shut-down of the boilers in case of sudden loss of line pressure as from a pipe break.
- K. To expedite the repair of the pipe, the County should negotiate with a selected mechanical contractor. The selected contractor can then assist in pre-construction activity so the work flows more smoothly. The contractor can assist with evaluating the differences in multiple shifts or extended hours of construction or overtime. The contractor can evaluate welding procedures for steel pipe and multiple shifts.

We further recommend that King County hire Auburn Mechanical Inc. In addition to the above, Auburn's offices are relatively close to the project site and they have two experienced crews available so that the project can start promptly and be completed sooner.

- L. Temporary heating for the dormitory wings can be provided to minimize the inconvenience of the piping replacement. A temporary gas-fired unit will also be available for installation in case of an unplanned disruption. We are planning on this outside air unit to connect into the rooftop units so that operations can be maintained. We will investigate if extending the gas line is more cost effective or using a propane tank. We estimate this unit to add approximately \$76,000 to the project cost. We will check the roof for the added weight and the power for the fan.





The cost estimate has been prepared based on the following:

- A. Replace copper pipe with welded steel.
- B. All work being done during normal business hours and at night. Since night work is approximately 20% more expensive than day work and since the work will be approximately half of each, the overall cost of the project will be approximately 10% more expensive, and the work will be done in approximately half the time.
- C. All work scheduled to minimize disruption to occupants of the building. For instance:
  1. Pipes in general will be run parallel to existing mains so that service can be maintained. New pipes will then be "cut-in" at the point of connection.
  2. Boilers will be shut down a minimum number of times.
  3. Much of the pipe is branch pipe and it can be isolated with valves at the mains.
- D. All work at estimated negotiated rates.
- E. Reasonable allowance for security provisions to get tradesmen and the tools into the work areas. This presumes a daily security check. By reasonable, we anticipate that each tradesman will be subject (once) to a background check by Washington State Patrol (or other agency) and their tools will be stored in the facility so that daily security checks can be expedited.
- F. Escort of tradesmen will be handled by King County so that the time can be spent on the piping.
- G. The following trades are involved:
  1. Pipe fitters
  2. Insulators
  3. Plumbers
  4. Carpenters (to remove and replace ceilings and walls)
- H. Piping costs have been volatile over the last twelve months with stories of theft of copper from job sites for salvage. That would imply that with different economic times, the installed costs would be lower. This report does not attempt to predict that situation, but we are using our best estimate of the value of the piping involved.

**Cost Estimate Summary  
continued**

**Summary**

The probable construction cost can be subdivided into the major components of the work as follows:

Domestic water in water heaters (WHs, in each detention unit).	\$611,403 <i>(pp 1 of 6)</i>
Space heat via heat recovery air handlers (HRUs) in the detention units and space heat via built-up air handlers (AHUs) in the Courts Building. Included is a temporary make-up air unit.	\$427,747 <i>(pp 2 of 6)</i>
Space heat in VAV boxes (FBCO = Fan box constant output) and fan coil units (FCUs) in the Courts Building and Detention Building.	\$165,076 <i>(pp 3 of 6)</i>
CHWS mains between the above components in the smaller sizes – three-inch and less).	\$220,020 <i>(pp 4 of 6)</i>
<b>Total Mechanical Cost For Piping</b>	<b>\$1,424,246</b>
General conditions – Site clean up, project management, bond	347,757 <i>(pp 5 of 6)</i>
Design contingency	\$265,800
<b>MACC</b>	<b>\$ 2,037,803</b>

Exclusions:

- Sales Tax
- Engineering Fees, Testing
- County Construction Management

See Appendix 1 for cost breakdowns.

Sazan  
Group  
Inc.



# Comparison of Piping Costs

Job Name	King Co Regional Justice Center (RJC)	Job Number	298-0836	Date	17-Nov-08	Overhead	15%
	Basis Study			By	RW	Profit	15%

2009-0154 Attachment B

Description	Unit	Quantity	Material		Labor		Equipment		Total with OH&P	
			Per Unit	Total	Per Unit	Total	Per Unit	Total	Per Unit	Total
Piping Comparisons - Copper - Steel										
Copper- Brazed K- Straight- 1-1/2"	lf	100	3.56	356.00	6.35	635.00			13	1,288
Fittings - 1-1/2" Elbows	ea	12	5.90	70.80	36.75	441.00			55	665
Insulation - 2.5"	lf	100	10.76	1,076.00			3,352.44		14	1,399
Steel - Welded Joints -1-1/2"	lf	100								
Fittings - 1-1/2" Elbows	ea	12	2.83	283.00	7.15	715.00			13	1,297
Insulation	lf	100	7.05	84.60	50.00	600.00			74	890
			10.76	1,076.00			3,586.18		14	1,399
Copper- Brazed - Straight - 3"	lf	100								
Fittings - 3" Elbows	ea	12	10.95	1,095.00	10.55	1,055.00			28	2,795
Insulation	lf	100	30.00	360.00	78.00	936.00			140	1,685
			12.60	1,260.00			6,117.80		16	1,638
Steel - Welded Joints -3"	lf	100								
Fittings - 3" Elbows	ea	12	7.95	795.00	13.25	1,325.00			28	2,756
Insulation	lf	100	10.90	130.80	92.60	1,111.20			135	1,615
			12.60	1,260.00			6,008.60		16	1,638
Copper - Brazed - 1"	lf	100								
Fittings	ea	12	2.27	227.00	4.80	480.00			9	919
Insulation	lf	100	2.55	30.60	39.90	478.80			55	662
			7.15	715.00			2,510.82		9	930
Steel - Welded -1"	lf	100								
Fittings	ea	12	2.04	204.00	6.00	600.00			10	1,045
Insulation	lf	100	7.05	84.60	40.36	484.32			62	740
			7.15	715.00			2,714.30		9	930
Totals										

# Cost Estimate

Job Name	King Co Regional Justice Center (RJC)	Job Number	298-0836	Date	17-Nov-08	Overhead	15%
Basis	Study - Water Heaters			By	RW	Profit	15%

Description	Unit	Quantity	Material		Labor		Equipment		Total with OH&P	
			Per Unit	Total	Per Unit	Total	Per Unit	Total	Per Unit	Total
1 Water Heater - Re-Pipe - 1-1/2" Pipe	lf	240		8,640.00						
Hang new pipe with insul	ea	1	36.00	36.00					47	11,232
Premium in pipe chase	ea	1	2,300.00	2,300.00						2,990
Drain CHWS in pipes	ea	1	480.00	480.00						624
Cut over - 1-1/2" each end (4)	lf	40	36.00	1,440.00						1,872
Fittings	assbly	4	1,200.00	4,800.00						6,240
Miscellaneous t'moms, drains	ls	1	500.00	500.00						650
Test	ea	1	400.00	400.00						520
Certify	ea	1	300.00	300.00						390
Ceilings, misc wall repairs	ls	1	1,700.00	1,700.00						2,210
Boiler shut down - Not required										
Demolition	ls	1	1,800.00	1,800.00						2,340
Sub total each										26,728
Subtotal Water Heaters	ea	15	26,728.00	400,920.00						400,920
Security Time	ls	1								180,414
										581,334
Mechanical Budget										
Contingency, Mechanical Construction										
Mechanical Contract Amount										
Totals				423,280						581,334

# Cost Estimate

Job Name	King Co Regional Justice Center (RJC)	Job Number	298-0836	Date	17-Nov-08	Overhead	15%
Basis	Study - Air Handlers			By	RW	Profit	15%

Description	Unit	Quantity	Material		Labor		Equipment		Total with OH&P	
			Per Unit	Total	Per Unit	Total	Per Unit	Total	Per Unit	Total
2 Air Handlers - Re-Pipe - 1" Pipe										
Hang new pipe with insul	lf	70	27.00	1,890.00						
Premium in pipe chase	ea	1	1,500.00	1,500.00					35	2,457
Drain CHWS in pipes	ea	1	250.00	250.00						1,950
Cut over - 1" each end (4)	lf	20	27.00	540.00						325
Fittings	assbly	4	450.00	1,800.00						702
Miscellaneous f'moms, drains	ls	1	380.00	380.00						2,340
Test	ea	1	400.00	400.00						494
Certify	ea	1	300.00	300.00						520
Ceilings	ls	1	300.00	300.00						390
Boiler shut down - Not required										390
Demolition	ls	1	1,500.00	1,500.00						1,950
Sub total each										9,568
Subtotal Water Heaters	ea	19	9,568.00	181,792.00						181,792
Security Time	ls	1								81,806
										263,598
<b>Totals</b>				190,652						263,598

# Cost Estimate

Job Name	King Co Regional Justice Center (RJC)	Job Number	298-0836	Date	17-Nov-08	Overhead	15%
Basis	Study - VAV Boxes and Fan Coil Units			By	RW	Profit	15%

2009-0154 Attachment B

Description	Unit	Quantity	Material		Labor		Equipment		Total with OH&P	
			Per Unit	Total	Per Unit	Total	Per Unit	Total	Per Unit	Total
3 VAV Boxes and Fan Coils - Re-Pipe - 1-1/2" Pipe										
Re-pipe at 3-way valves plus										
Hang new pipe with insul	If	60	36.00	2,160.00					47	2,808
Premium in pipe chase	ea	1	2,600.00	2,600.00						3,380
Drain CHWS in pipes	ea	1	750.00	750.00						975
Cut over - 1-1/2" each end (4)	If	20	36.00	720.00						936
Fittings	assby	4	950.00	3,800.00						4,940
Miscellaneous t'moms, drains	ls	1	500.00	500.00						650
Test	ea	1	550.00	550.00						715
Certify	ea	1	300.00	300.00						390
Ceilings	ls	1	2,100.00	2,100.00						2,730
Boiler shut down - Required	ls	1	1,900.00	1,900.00						2,470
Demolition	ls	1	1,400.00	1,400.00						1,820
Sub total each										17,524
Subtotal Water Heaters (6 zones)	ea	6	17,524.00	105,144.00						105,144
Security Time	ls	1								47,315
										152,459
Mechanical Budget										
Contingency, Mechanical Construction										
Mechanical Contract Amount										
Totals				121,924						152,459

# Cost Estimate

Job Name	King Co Regional Justice Center (RJC)	Job Number	298-0836	Date	17-Nov-08	Overhead	15%
	Basis Study - Mains			By	RW	Profit	15%

2009-01-14 Attachment B

Description	Unit	Quantity	Material		Labor		Equipment		Total with OH&P	
			Per Unit	Total	Per Unit	Total	Per Unit	Total	Per Unit	Total
4 Mains - Re-Pipe - 3" Pipe										
Hang new pipe with insul	lf	540	60.00	32,400.00						78
Premium in pipe chase	ea	1	8,400.00	8,400.00						10,920
Drain CHWS in pipes	ea	1	2,400.00	2,400.00						3,120
Cut over - 1-1/2" each end (4)	lf	20	60.00	1,200.00						1,560
Fittings	assy	8	2,800.00	22,400.00						29,120
Miscellaneous t'noms, drains	ls	1	1,300.00	1,300.00						1,680
Test	ea	1	900.00	900.00						1,170
Certify	ea	1	900.00	900.00						1,170
Ceilings, wall repair	ls	1	7,000.00	7,000.00						9,100
Boiler shut down - Required	ls	1	1,900.00	1,900.00						2,470
Demolition	ls	1	4,000.00	4,000.00						5,200
Controls										
Facility	ls	1	10,000.00	10,000.00						13,000
Vendor	ls	1	15,000.00	15,000.00						19,500
Sub total each										140,140
Subtotal Mains	ea	1	140,140.00	140,140.00						140,140
Security Time	ls	1								63,063
										203,203
Mechanical Budget										
Contingency, Mechanical Construction	203,203									
Mechanical Contract Amount	40,641									
	243,844									
Totals				247,940						203,203







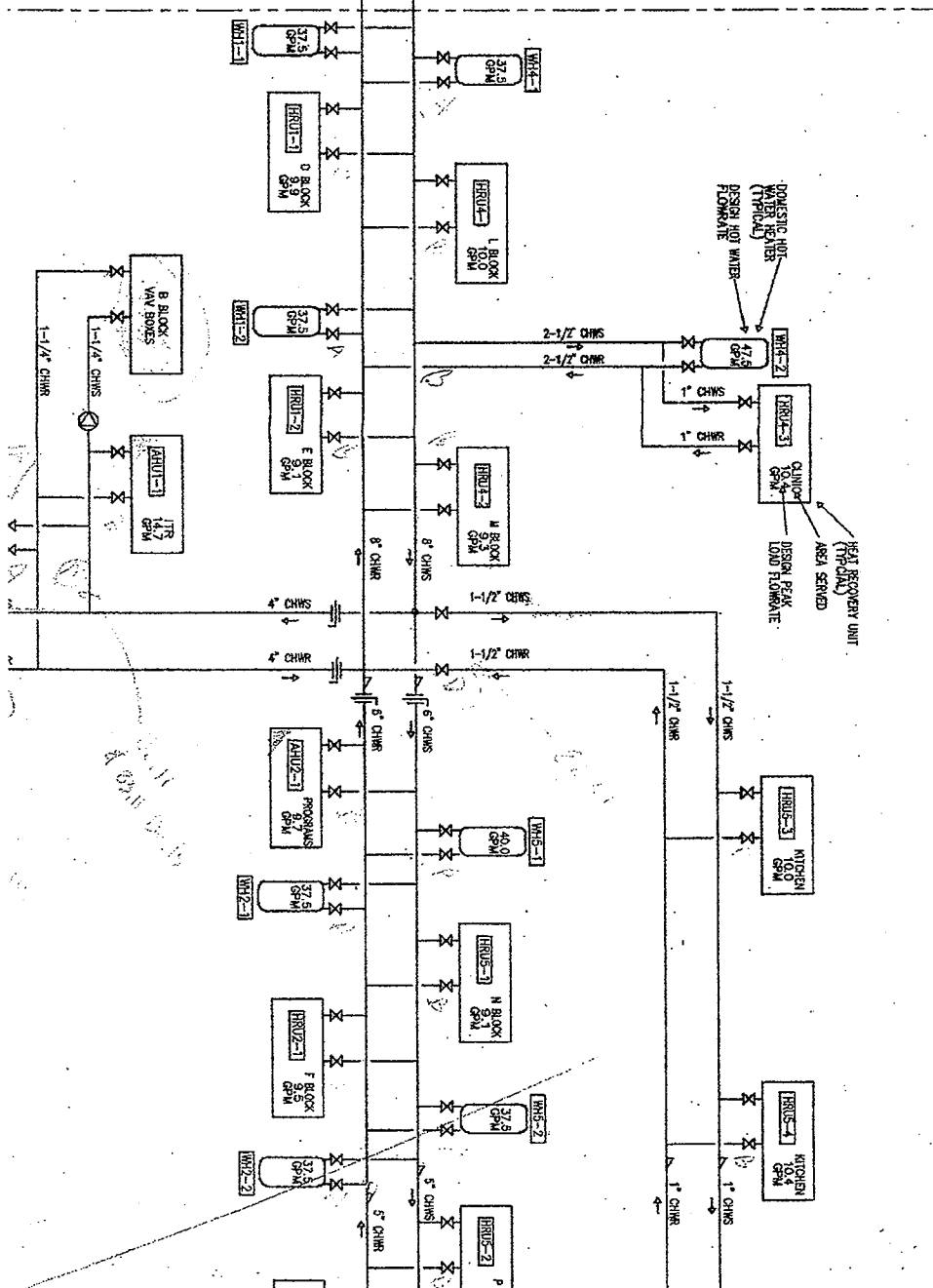
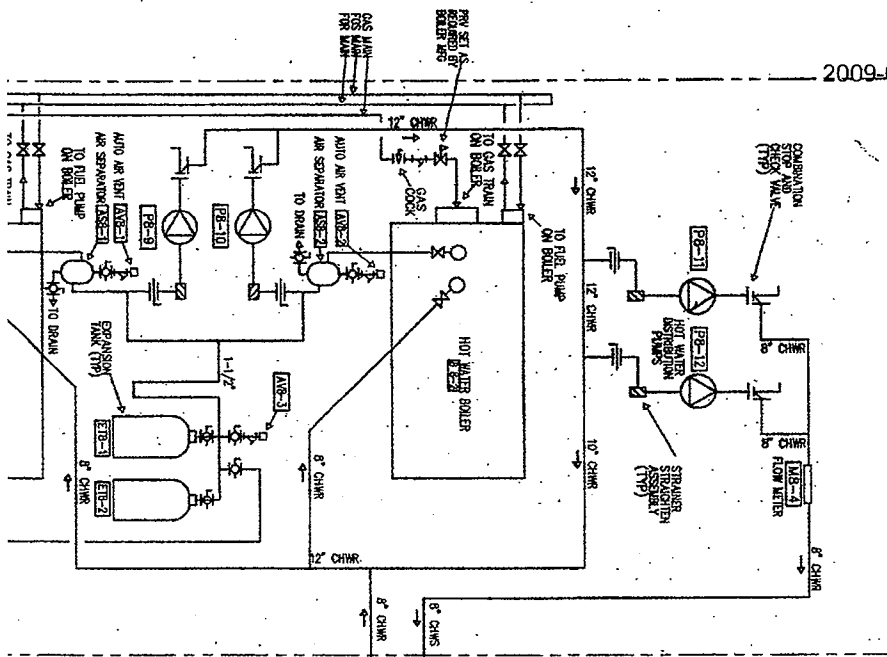

UNIT-3

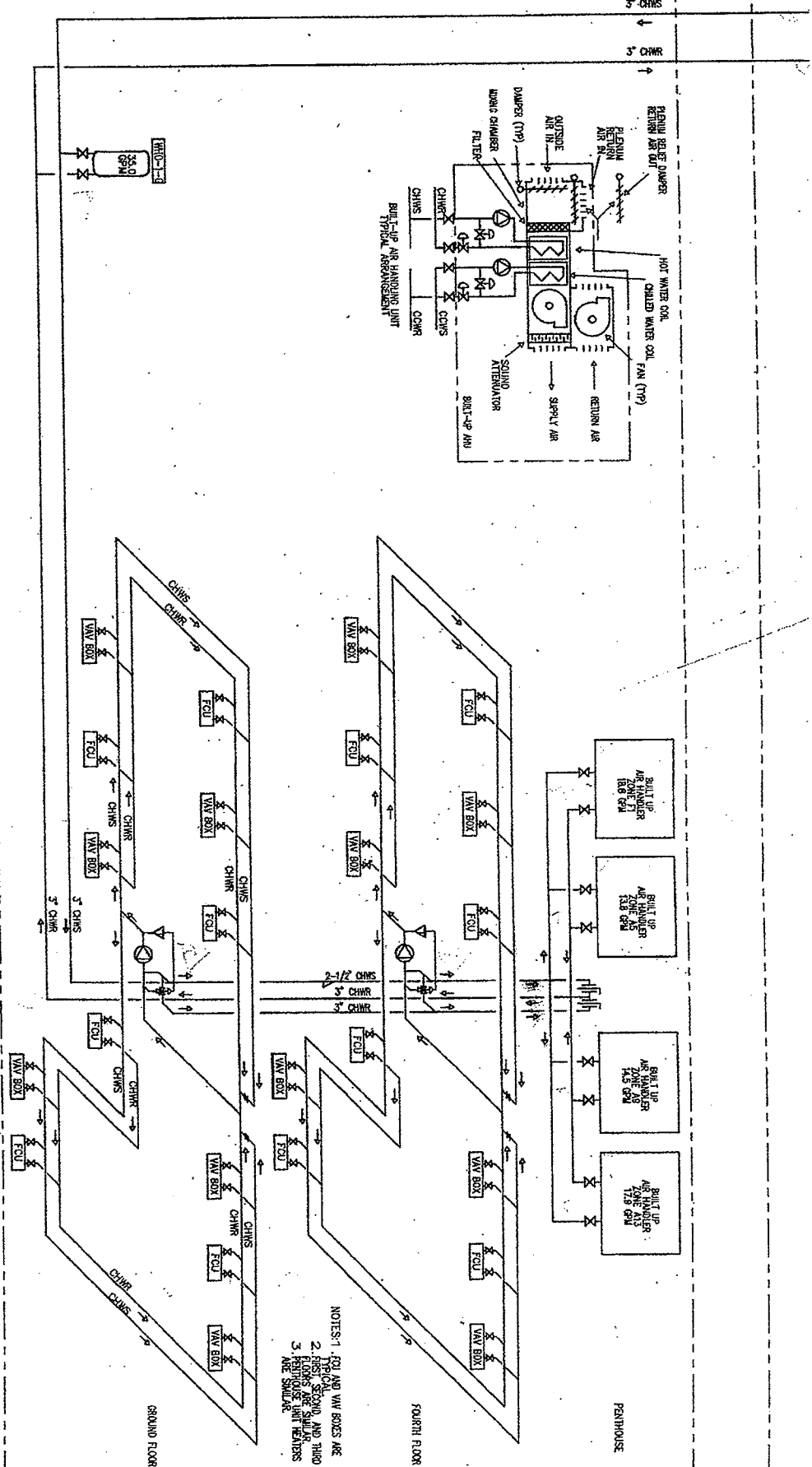

NOTES: 1. FOU AND VAV BOXES ARE  
 2. FLOOR, ROOM, AND RHO  
 3. PENHOUSES UNIT HEATERS  
 ARE SIMILAR

1 HEATING WATER DIAGRAM  
 NO SCALE

SEC 3 PIPING DIAGRAMS

Sheet No. 35837-07  
 Project No. 2009-0154  
 Date 1/1/07  
 Can

11/12/2008 P:\2008-0154-KC-KC-Fair-Pipe\DWG\KJ0101.dwg

ADDITIONAL SHEET INFORMATION

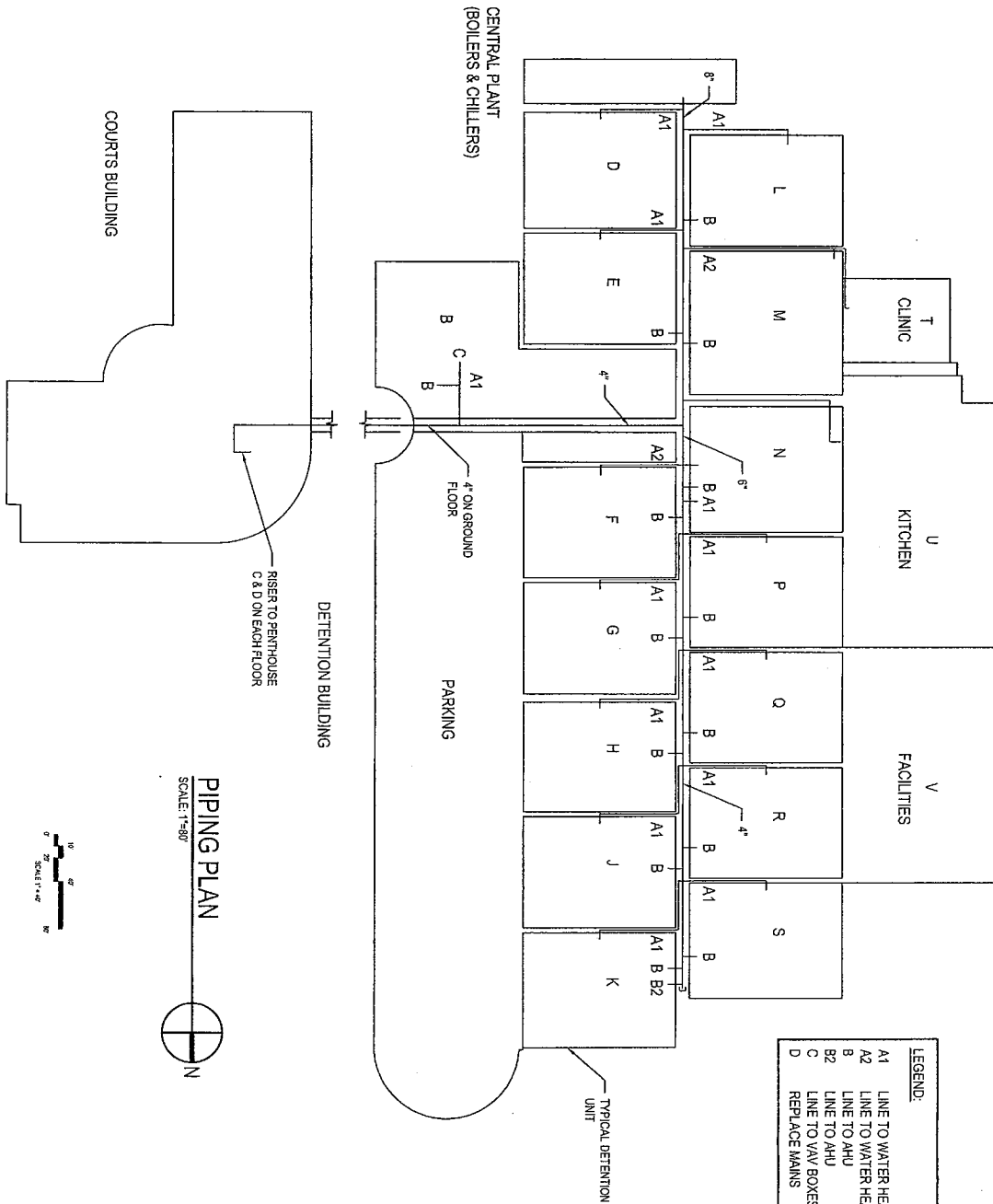

**LEGEND:**

A1	LINE TO WATER HEATERS	1-1/2"
A2	LINE TO WATER HEATERS	2-1/2"
B	LINE TO AHU	1"
B2	LINE TO AHU	2-1/2"
C	LINE TO VAV BOXES	2-1/2"
D	REPLACE MAINS	2-1/2"

**PIPING PLAN**  
SCALE: 1"=80'

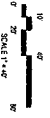

Engineering and Consultant Services  
**Sözan Group, Inc.**  
 730 Ohio, Suite 1525  
 Solon, Westborough 98101  
 (204) 201-1720

KENT REGIONAL  
 JUSTICE CENTER  
 CITY OF KENT

SUBMITTAL TYPE

NAME:	KENTON
DATE:	NOVEMBER 28, 2008
PROJECT:	KENT REGIONAL JUSTICE CENTER
DATE:	NOVEMBER 28, 2008

**M1**



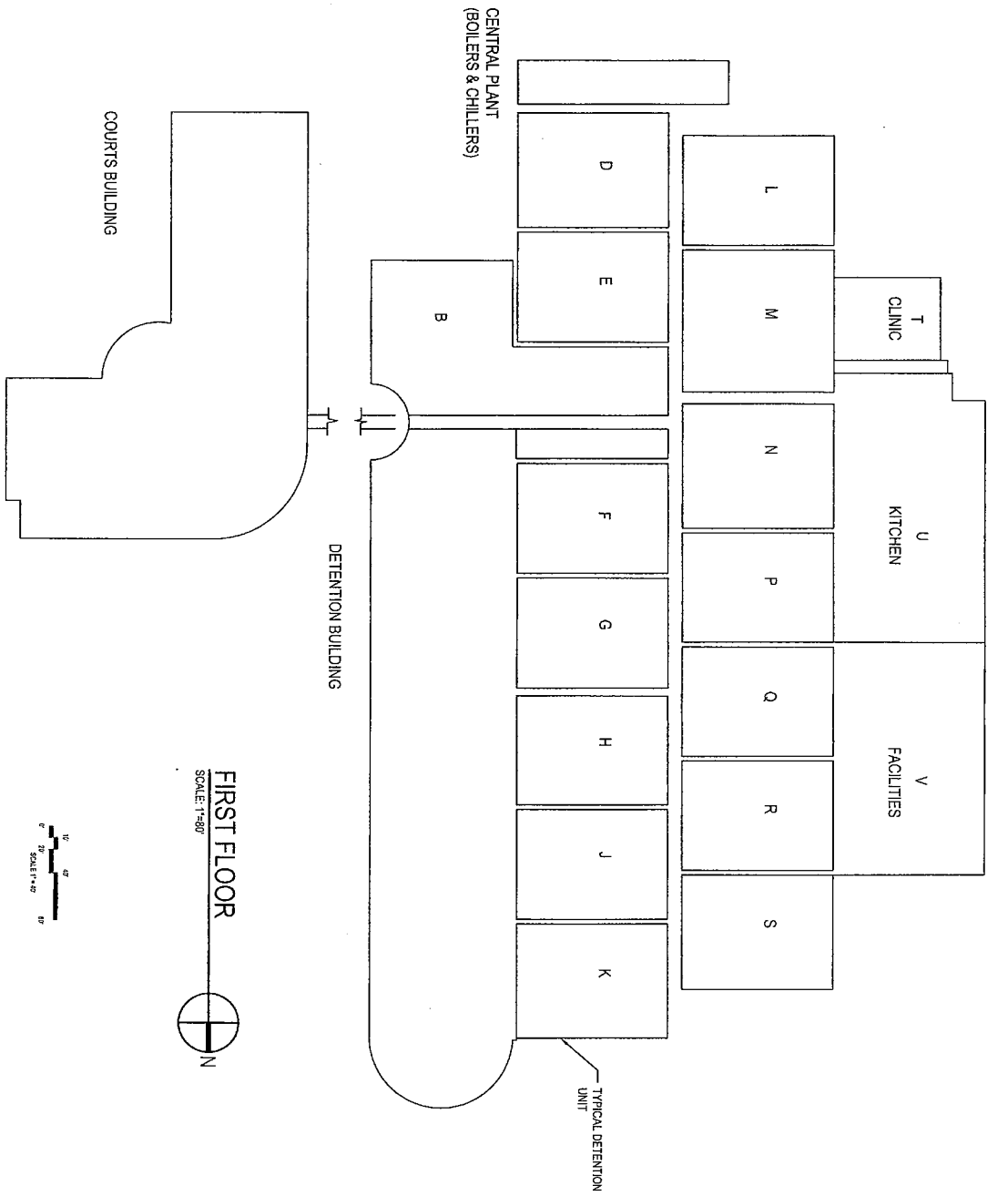

FIRST FLOOR  
SCALE: 1"=80'

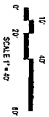

Engineering and Construction Services  
**Sözön Group, Inc.**  
 770 Ohio State 1572  
 Solon, WAshington 98101  
 (206) 267-1700



KENT REGIONAL  
 JUSTICE CENTER  
 CITY OF KENT

SUBMITTAL  
 TYPE

Project:	200908
Contract:	
Date:	NOVEMBER 2008
Drawn:	
Checked:	
Scale:	
Sheet:	

M3





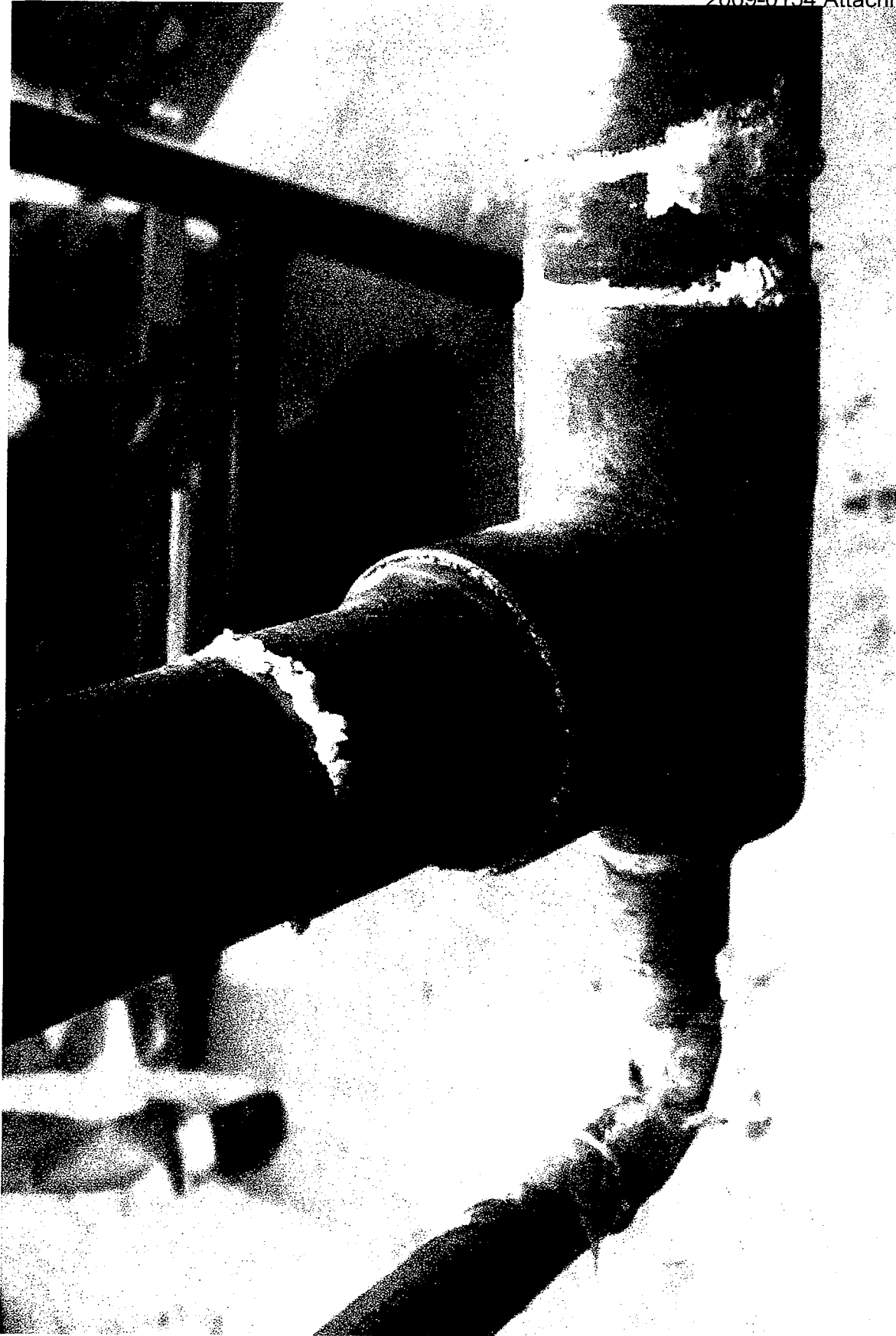

P-1 Pipe Sample At Water Heater  
Crystalline substance at joints is like a salt from a pipe weep (instead of from a drip/leak).



P-2 Pipe At Water Heater  
Crystalline substance is a salt-like structure. Fuzzy material is leftover fiberglass insulation.

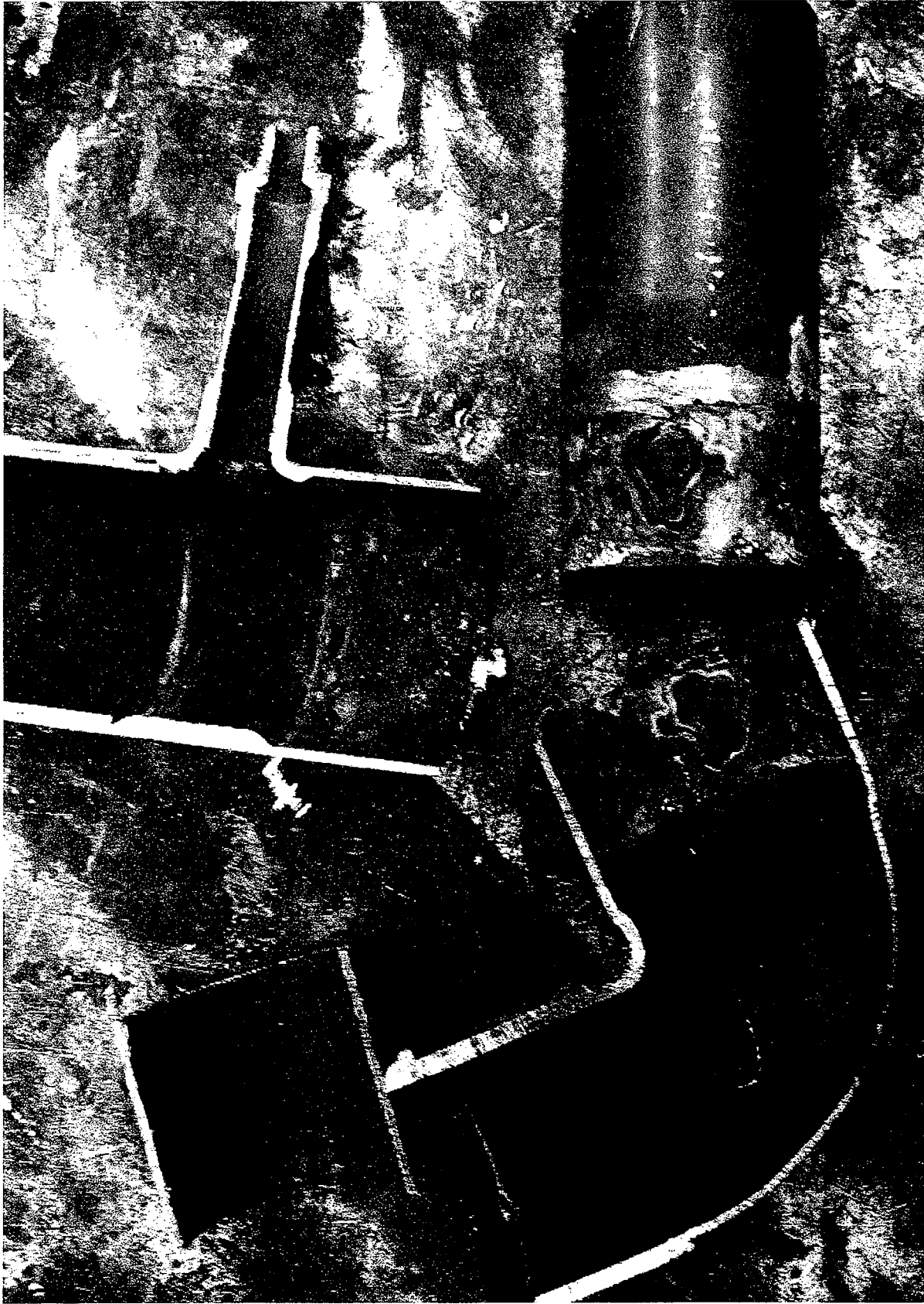

P-3 Pipe Joint Samples  
Solder is uneven and spotty.

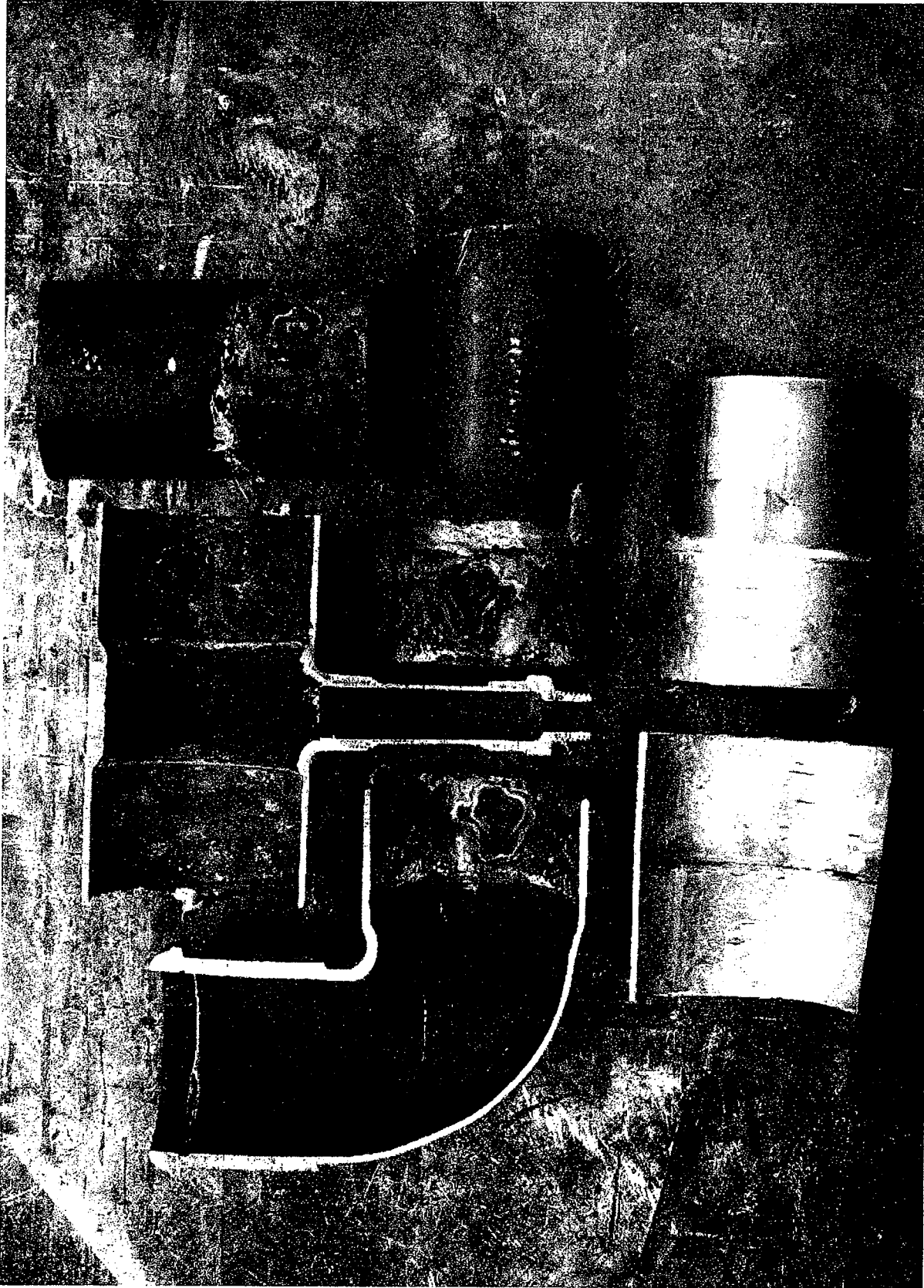

P-4 Pipe Joint Samples  
Solder is uneven. For contract, the lower sample is a freshly made joint which was then cut apart.

**P-5 Pipe Section**

This is a 4-foot section of pipe which was removed and mounted on a pipestand in the Plumbing Shop. Note crystalline substance on joints.

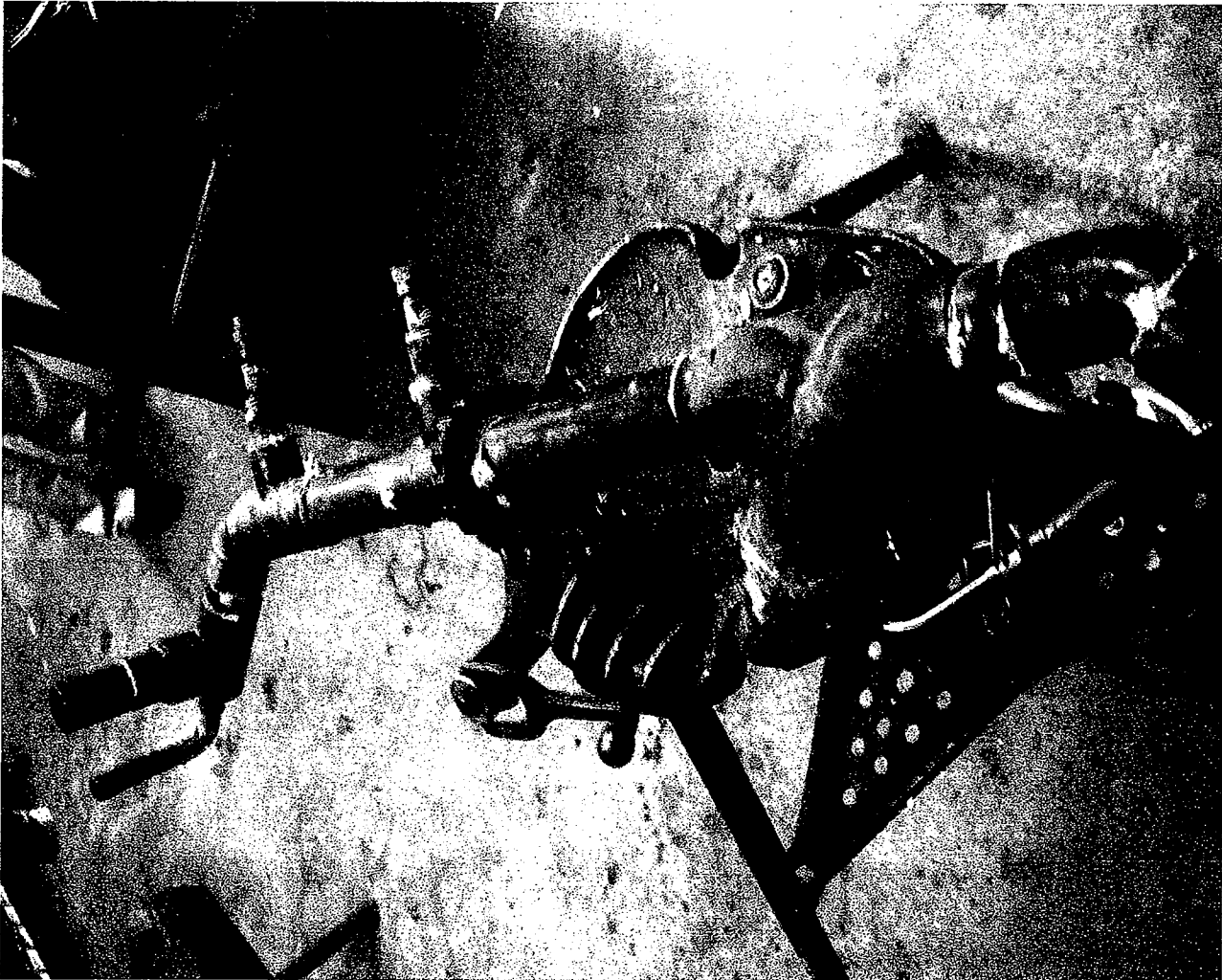

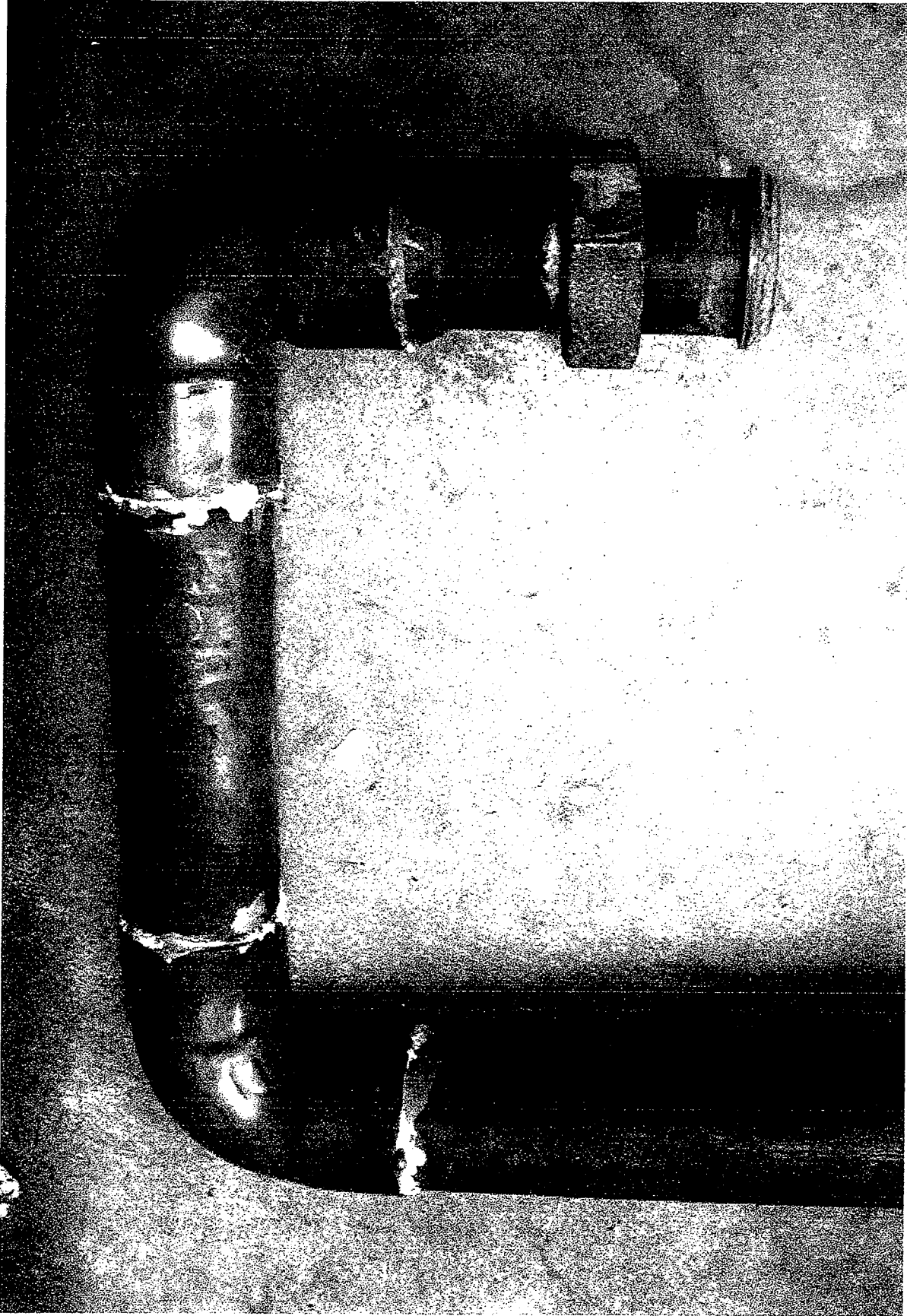

P-6 Pipe Samples  
Sample of a section of 1-1/2" pipe. Each joint looks poorly made.



P-7 Pipe  
Typical field photo at a water heater.

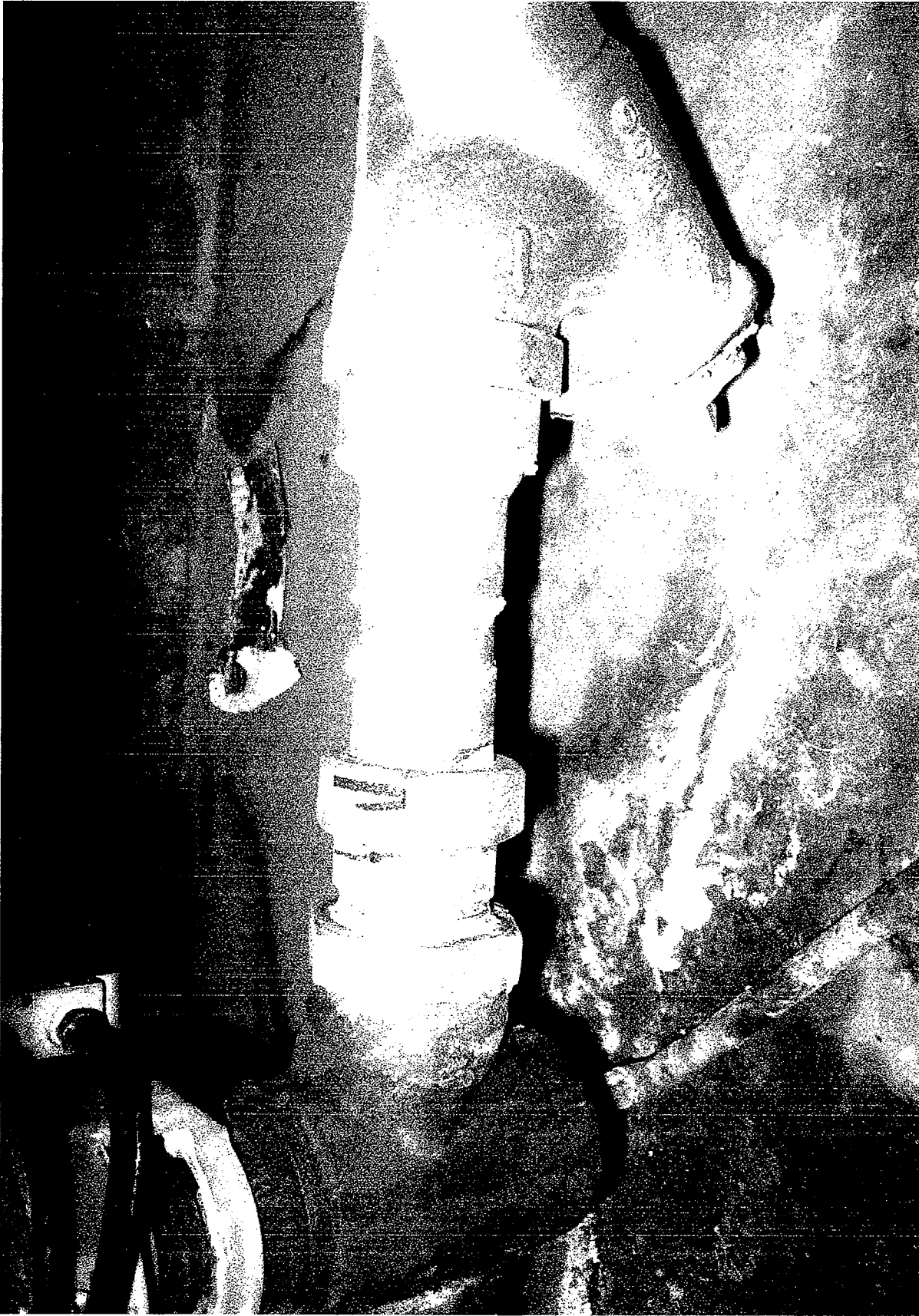

P-8 Pipe  
Typical field photo at a water heater.



P-9 Pipe  
Typical water heater in a dormitory unit (typical of  
15 units).

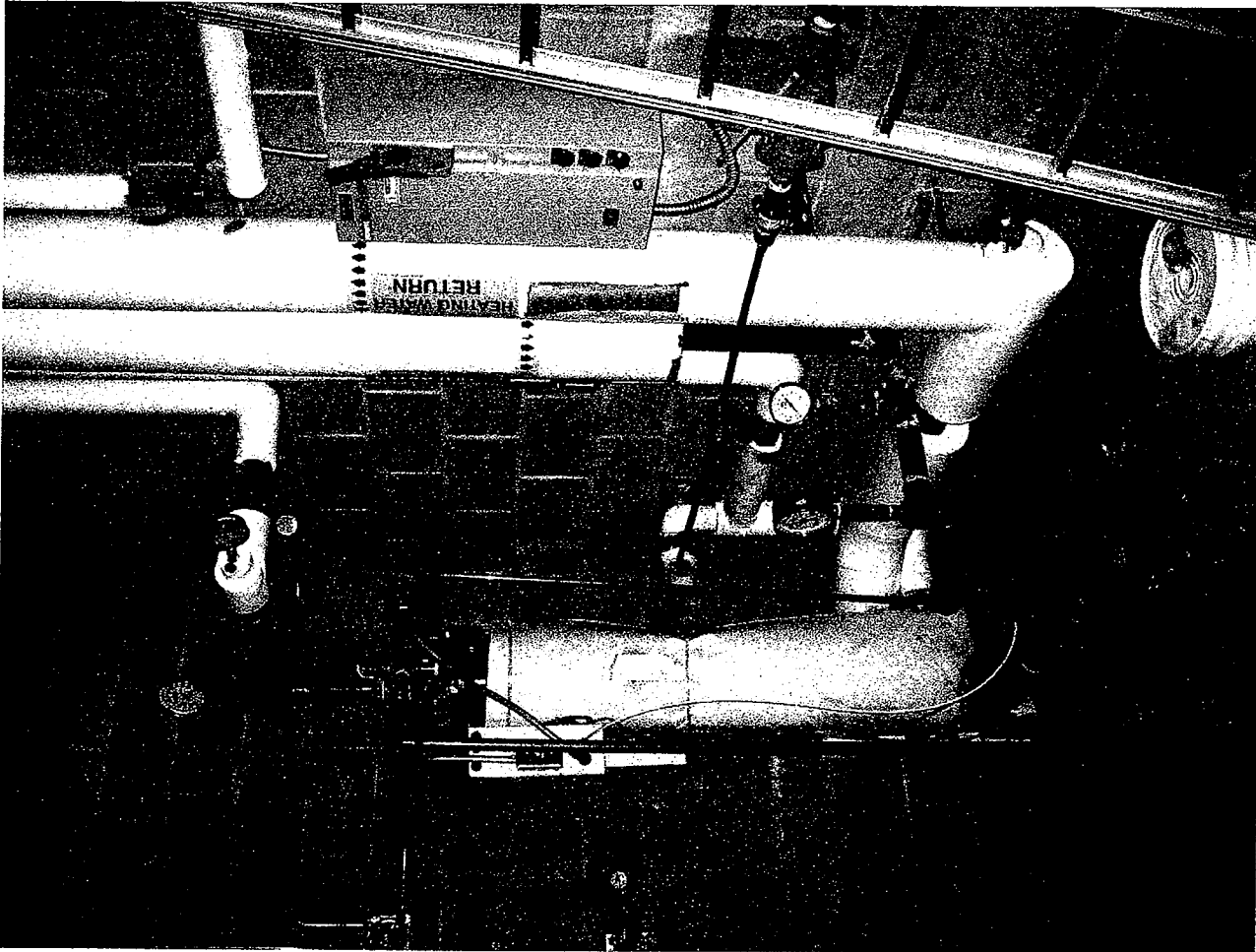



October 31, 2008

Richard Ward  
 Sazan Group  
 820 Olive Way Ste. 1525  
 Seattle, WA 98101



RE: Metals Analysis; NVL Batch # 2813835.00

Dear Mr. Ward,

Enclosed please find the test results for samples submitted to our laboratory for analysis. Examination of these samples was conducted using analytical instruments in accordance to U.S. EPA, NIOSH, OSHA and other ASTM methods.

For matrix materials submitted as paint, dust wipe, soil or TCLP samples, analysis for the presence of total metals is conducted using published U.S. EPA Methods. Paint and soil results are usually expressed in mg/Kg which is equivalent to parts per million (ppm). Lead (Pb) in paint is usually expressed in mg/Kg (ppm), Percent (%) or mg/cm<sup>2</sup> by area. Dust wipe sample results are usually expressed in ug/wipe and ug/ft<sup>2</sup>. TCLP samples are reported in mg/L (ppm). For air filter samples, analyses are conducted using NIOSH and OSHA Methods. Results are expressed in ug/filter and ug/m<sup>3</sup>. Other matrix materials are analyzed accordingly using published methods or specified by client. The reported test results pertain only to items tested. Lead test results are not blank corrected.

For recent regulation updates pertaining to current regulatory levels or permissible exposure levels, please call your local regulatory agencies for more details.

This report is considered highly confidential and will not be released without your approval. Samples are archived for two weeks following analysis. Samples that are not retrieved by the client are discarded after two weeks.

Thank you for using our laboratory services. If you need further assistance please feel free to call us at 206-547-0100 or 1-888-NVLLABS.

Sincerely,

Nick Ly, Technical Director

Enclosure:

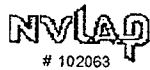

AIHA - IH  
 #101861

NVLLABS, INC  
 18 AURORA AVE N  
 TTLC, WA 98103-5516

547.0100

206.634.1936

labs@nvlabs.com

www.nvlabs.com  
 1.888.NVLLABS (685.5227)

4708 Aurora Ave. N., Seattle, WA 98103  
 Tel: 206.547.0100, Fax: 206.634.1936  
 www.nvllabs.com

**Analysis Report**

AIHA - IH # 101861  
 WA - DOE # C1765



**Total Lead (Pb)**

Client: Sazan Group  
 Address: 820 Olive Way Ste. 1525  
 Seattle, WA 98101

**Batch #: 2813835.00**

Matrix: Paint Chips  
 Method: EPA 7000B  
 Client Project #: 2980836  
 Date Received: 10/30/2008  
 Samples Received: 1  
 Samples Analyzed: 1

Attention: **Mr. Richard Ward**  
 Project Location: Kent

Lab ID	Client Sample #	Sample Weight	RL in mg/Kg	Results in mg/Kg	Results in percent
28087863	Sample 1	0.2256	40.0	170.0	0.0170

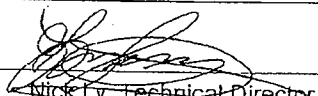
Sampled by: Client  
 Analyzed by: Tanveer Khan  
 Reviewed by: Nick Ly  
 Date Analyzed: 10/31/2008  
 Date Issued: 10/31/2008  
  
 Nick Ly, Technical Director

mg/ Kg =Milligrams per kilogram

Percent = Milligrams per kilogram / 10000

Note : Method QC results are acceptable unless stated otherwise.

Unless otherwise indicated, the condition of all samples was acceptable at time of receipt.

RL = Reporting Limit

'<' = Below the reporting Limit

**NVL Laboratories, Inc.**

4708 Aurora Ave N, Seattle, WA 98103  
 Tel: 206.547.0100 Emerg. Cell: 206.914.4646  
 1.888.NVL.LABS (685.5227) www.nvllabs.com

**CHAIN OF CUSTODY  
 SAMPLE LOG**

2009-0154 Attachment B



Client Sazan Group  
 Address 820 Olive Way Ste. 1525  
Seattle, WA 98101  
 Project Manager Mr. Richard Ward  
 Project Location Kent

NVL Batch Number 2813835.00  
 Client Job Number 2980836  
 Total Samples 1 Rush Samples \_\_\_\_\_  
 TAT 4-Hrs Rush TAT \_\_\_\_\_ AH: \_\_\_\_\_  
 Due Date 10/31/2008 Time 11:51 AM  
 Email address rward@sazan.com

Phone: (206) 267-1700 Fax: (206) 267-1701 Cell (206) 409-8904

Asbestos Air  PCM (NIOSH 7400)  TEM (NIOSH 7402)  TEM (AHERA)  TEM (EPA Level II)  Other \_\_\_\_\_  
 Asbestos Bulk  PLM (EPA/600/R-93/116)  PLM (EPA Point Count)  PLM (EPA Gravimetry)  TEM BULK  
 Mold/Fungus  Mold Air  Mold Bulk  Rotometer Calibration

METALS	Inst/Det.Limit	Matrix	RCRA Metals
<input checked="" type="checkbox"/> Total Metals	<input checked="" type="checkbox"/> FAA (ppm)	<input type="checkbox"/> Air Filter	<input type="checkbox"/> Arsenic (As) <input checked="" type="checkbox"/> Lead (Pb)
<input type="checkbox"/> TCLP	<input checked="" type="checkbox"/> TCP (ppm)	<input type="checkbox"/> Drinking water	<input type="checkbox"/> Barium (Ba) <input type="checkbox"/> Mercury (Hg) <input type="checkbox"/> Copper (Cu)
<input type="checkbox"/> Cr 6	<input type="checkbox"/> GFAA (ppb)	<input type="checkbox"/> Dust/wipe (Area)	<input type="checkbox"/> Cadmium (Cd) <input type="checkbox"/> Selenium (Se) <input type="checkbox"/> Nickel (Ni)
	<input type="checkbox"/> CVAA (ppb)	<input type="checkbox"/> Soil	<input type="checkbox"/> Chromium (Cr) <input type="checkbox"/> Silver (Ag) <input type="checkbox"/> Zinc (Zn)
<input type="checkbox"/> Other Types of Analysis	<input type="checkbox"/> Fiberglass	<input type="checkbox"/> Nuisance Dust	<input type="checkbox"/> Other (Specify) _____
	<input type="checkbox"/> Silica	<input type="checkbox"/> Respirable Dust	

Condition of Package  Good  Damaged (no spillage)  Severe damage (spillage)

1	28087863	Sample 1	A
---	----------	----------	---

FAILD VISA  
 10/30/08 SM

	Print Below	Sign Below	Company	Date	Time
Sampled by	Client	<i>Richard Ward</i>	<i>Sazan Group</i>	<i>10/30/08</i>	<i>1751</i>
Relinquished by	Client	<i>Shaista Khan</i>	NVL	<i>10/30/08</i>	<i>1751</i>
Received by	Shaista Khan	<i>Shaista Khan</i>	NVL	<i>10/31/08</i>	<i>10:30 AM</i>
Relinquished by		<i>Tanveer Khan</i>	NVL	<i>10/31/08</i>	<i>10:58 AM</i>
Analyzed by	<i>TANVEER KHAN</i>	<i>Tanveer Khan</i>	NVL	<i>10/31/08</i>	<i>10:30 AM</i>
Results Called by		<i>Tanveer Khan</i>	NVL	<i>10/31/08</i>	<i>10:58 AM</i>

Special Instructions: Unless requested in writing, all samples will be disposed of two (2) weeks after analysis.  
 Please fax results to the above number

October 31, 2008

Richard Ward  
Sazan Group  
820 Olive Way Ste. 1525  
Seattle, WA 98101



RE: Metals Analysis; NVL Batch # 2813836.00

Dear Mr. Ward,

Enclosed please find the test results for samples submitted to our laboratory for analysis. Examination of these samples was conducted using analytical instruments in accordance to U.S. EPA, NIOSH, OSHA and other ASTM methods.

For matrix materials submitted as paint, dust wipe, soil or TCLP samples, analysis for the presence of total metals is conducted using published U.S. EPA Methods. Paint and soil results are usually expressed in mg/Kg which is equivalent to parts per million (ppm). Lead (Pb) in paint is usually expressed in mg/Kg (ppm), Percent (%) or mg/cm<sup>2</sup> by area. Dust wipe sample results are usually expressed in ug/wipe and ug/ft<sup>2</sup>. TCLP samples are reported in mg/L (ppm). For air filter samples, analyses are conducted using NIOSH and OSHA Methods. Results are expressed in ug/filter and ug/m<sup>3</sup>. Other matrix materials are analyzed accordingly using published methods or specified by client. The reported test results pertain only to items tested. Lead test results are not blank corrected.

For recent regulation updates pertaining to current regulatory levels or permissible exposure levels, please call your local regulatory agencies for more details.

This report is considered highly confidential and will not be released without your approval. Samples are archived for two weeks following analysis. Samples that are not retrieved by the client are discarded after two weeks.

Thank you for using our laboratory services. if you need further assistance please feel free to call us at 206-547-0100 or 1-888-NVLLABS.

Sincerely,

Nick Ly, Technical Director

Enclosure:



AIHA - IH  
#101861

NVLLABS, INC  
38 AURORA AVE N  
LITTLE, WA 98103.6515  
547.0100  
5634.1936  
labs@nvllabs.com

www.nvllabs.com  
1.888.NVLLABS (685.5227)

**NVL Laboratories, Inc.**

4708 Aurora Ave. N., Seattle, WA 98103  
 Tel: 206.547.0100, Fax: 206.634.1936  
 www.nvllabs.com

2009-0154 Attachment B

**Analysis Report**

AIHA - IH # 101861  
 WA - DOE # C1765

**Total Metals**

Client: Sazan Group  
 Address: 820 Olive Way Ste. 1525  
 Seattle, WA 98101

**Batch #: 2813836.00**

Matrix: Pipe

Method: EPA 6010

Client Project #: 2980836

Date Received: 10/30/2008

Samples Received: 1

Samples Analyzed: 1

Attention: **Mr. Richard Ward**  
 Project Location: Kent

Lab ID	Client Sample #	Elements	Sample wt (g)	RL mg / kg	Results in mg / kg	Results in ppm
28087864	Sample 2- New Pipe	Antimony (Sb)	1.9260	1.0	< 1.0	< 1.0
		Tin (Sn)	1.9260	1.0	2.8	2.8

Sampled by: Client

Analyzed by: Michael Dougherty

Reviewed by: Nick Ly

Date Analyzed: 10/31/2008

Date Issued: 10/31/2008

Nick Ly, Technical Director

mg/ kg = Milligrams per kilogram

ppm = Parts per million

Note : Method QC results are acceptable unless stated otherwise.

Unless otherwise indicated, the condition of all samples was acceptable at time of receipt.

RL = Reporting Limit

'&lt;' = Below the reporting Limit

Bench Run No: 28-1031-02

**NVL Laboratories, Inc.**  
 4708 Aurora Ave N, Seattle, WA 98103  
 Tel: 206.547.0100 Emerg. Cell: 206.914.4646  
 1.888.NVL.LABS (685.5227) www.nvllabs.com

**CHAIN OF CUSTODY  
 SAMPLE LOG**

2009-0154 Attachment B  
  
 HAZARDOUS MATERIALS SERVICES

Client Sazan Group  
 Address 820 Olive Way Ste. 1525  
Seattle, WA 98101  
 Project Manager Mr. Richard Ward  
 Project Location Kent

NVL Batch Number 2813836.00  
 Client Job Number 2980836  
 Total Samples 1 Rush Samples \_\_\_\_\_  
 TAT 4-Hrs Rush TAT \_\_\_\_\_ AH: \_\_\_\_\_  
 Due Date 10/31/2008 Time 11:55 AM  
 Email address rward@sazan.com

Phone: (206) 267-1700 Fax: (206) 267-1701 Cell (206) 409-8904

Asbestos Air  PCM (NIOSH 7400)  TEM (NIOSH 7402)  TEM (AHERA)  TEM (EPA Level II)  Other  
 Asbestos Bulk  PLM (EPA/600/R-93/116)  PLM (EPA Point Count)  PLM (EPA Gravimetry)  TEM BULK  
 Mold/Fungus  Mold Air  Mold Bulk  Rotometer Calibration

METALS	Inst/Det/Limit	Matrix	RCRA Metals
<input type="checkbox"/> Total Metals	<input type="checkbox"/> FAA (ppm)	<input type="checkbox"/> Air Filter	<input checked="" type="checkbox"/> Paint Chips in %
<input type="checkbox"/> TCLP	<input checked="" type="checkbox"/> ICP (ppm)	<input type="checkbox"/> Drinking water	<input type="checkbox"/> Paint Chips in cn
<input type="checkbox"/> Cr 6	<input type="checkbox"/> GFAA (ppb)	<input type="checkbox"/> Dust/wipe (Area)	<input type="checkbox"/> Waste Water
	<input type="checkbox"/> CVAA (ppb)	<input type="checkbox"/> Soil	<input type="checkbox"/> Other _____
			<input type="checkbox"/> Arsenic (As) <input type="checkbox"/> Lead (Pb)
			<input type="checkbox"/> Barium (Ba) <input type="checkbox"/> Mercury (Hg)
			<input type="checkbox"/> Cadmium (Cd) <input type="checkbox"/> Selenium (Se)
			<input type="checkbox"/> Chromium (Cr) <input type="checkbox"/> Silver (Ag)
			<input type="checkbox"/> Copper (Cu)
			<input type="checkbox"/> Nickel (Ni)
			<input type="checkbox"/> Zinc (Zn)

Other Types of Analysis  Fiberglass  Nuisance Dust  Other (Specify) ANTIMONY + TIN  
 Silica  Respirable Dust

Condition of Package  Good  Damaged (no spillage)  Severe damage (spillage)

1	28087864	Sample 2- New Pipe	A
---	----------	--------------------	---

**PAID** VISA  
 \$105.32  
 [Signature]

	Print Below	Sign Below	Company	Date	Time
Sampled by	Client				
Relinquished by	Client	<u>Richard Ward</u>	<u>Sazan Group</u>		
Received by	Shaista Khan	<u>Shaista Khan</u>	NVL	10/30/08	1755
Relinquished by					
Analyzed by	<u>M. Dougherty</u>	<u>[Signature]</u>	NVL	10/31/08	11:00
Results Called by					
<input checked="" type="checkbox"/> Faxed <input type="checkbox"/> Emailed	<u>M. Dougherty</u>	<u>[Signature]</u>	NVL	10/31/08	11:10

Special Instructions: Unless requested in writing, all samples will be disposed of two (2) weeks after analysis.

Please fax results to the above number



17602

11/11/2008 12:59:05 PM

Solder Scraped from Straight Coupling

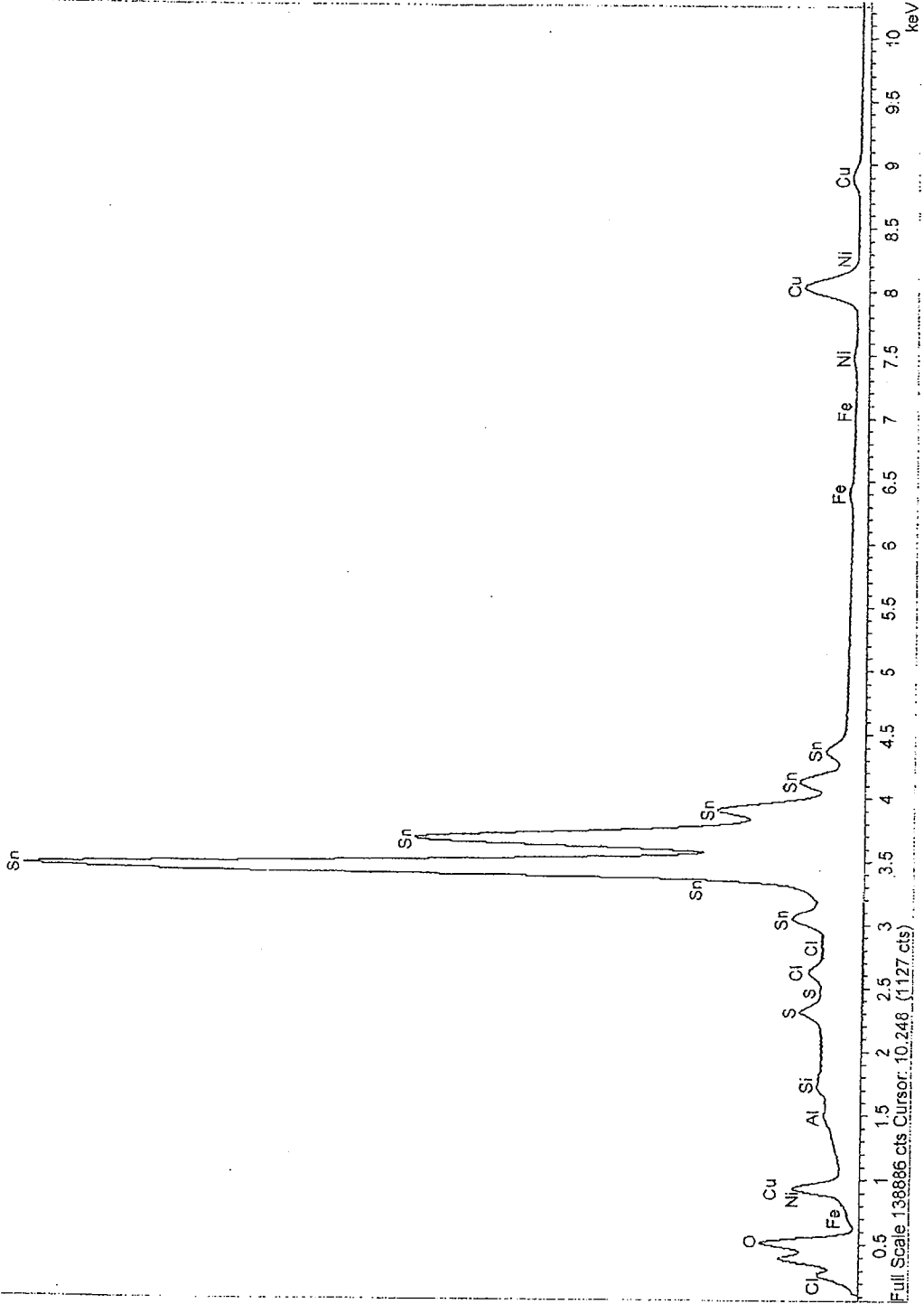

Comment:



17602

11/11/2008 1:30:40 PM

Corrosion from Tee Fitting

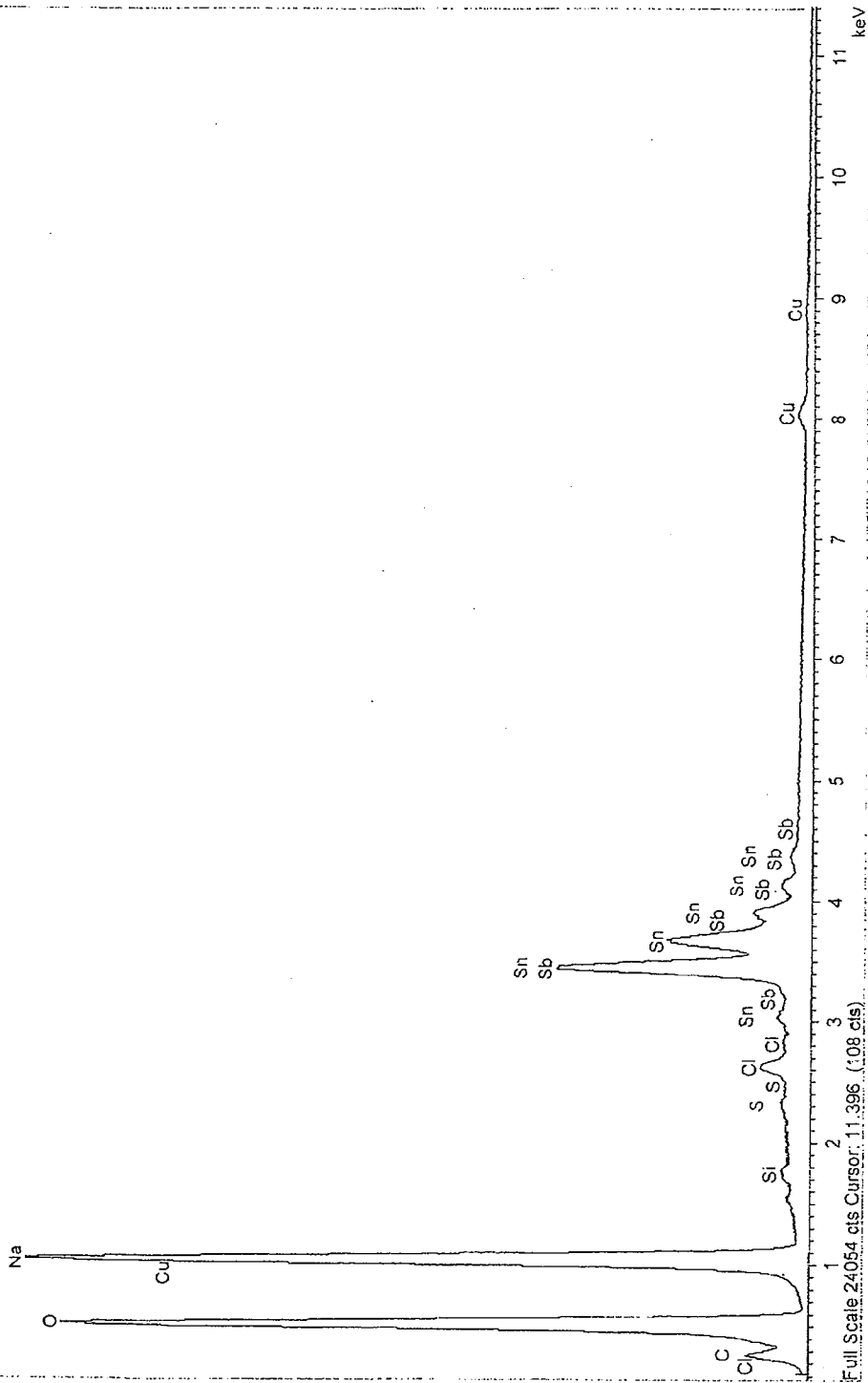

Comment:

17602

11/11/2008 2:24:56 PM

Corrosion from Straight Coupling

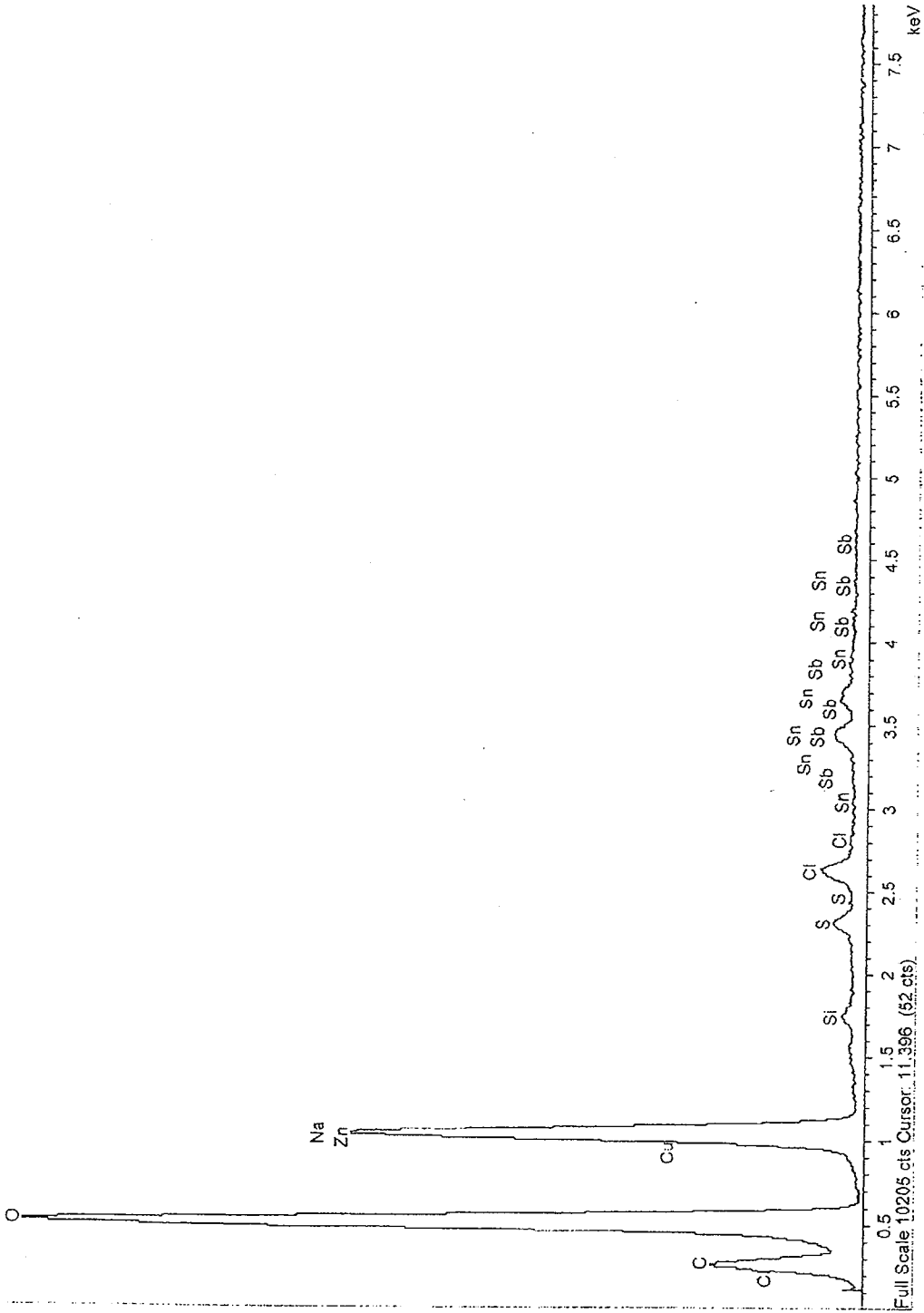

Comment:

